

sleep  number®

INNOVATION SERIES  
LIMITED EDITION  
BED ASSEMBLY GUIDE



# Welcome

## to Sleep Number

Congratulations on your purchase of the Sleep Number® bed. You've not only made a great decision to sleep your very best, you've joined the more than 10 million well-rested Insiders who are part of our InnerCircle<sup>SM</sup> family.

As an Insider, you'll be the first to know about our latest innovations and you'll always receive special savings on Sleep Number® beds and bedding. You can even earn rewards for sharing what you love about your bed with friends and family.\* Simply register your bed at [sleepnumber.com/innercircle](https://sleepnumber.com/innercircle) to start receiving all your exclusive benefits.

We believe the best sleep of your life begins with the Sleep Number® experience, and we look forward to further individualizing your comfort. Our Sleep Professionals are dedicated to your sleep for life.

Sleep well, dream big.

*Shelly Ibach*

Shelly Ibach, President and CEO  
My Sleep Number® setting is 35



\* See Owners' InnerCircle<sup>SM</sup> Rewards Section for details. SLEEP NUMBER, SELECT COMFORT, SLEEPIQ and the Double Arrow Design are registered trademarks of Select Comfort Corporation.

# What's Inside

Setting up your new Sleep Number® bed only takes about an hour and you'll enjoy the benefits of better sleep for years to come. You won't need any tools and, although it's nice to have a helper, you can do it by yourself.

NOTE: If you ordered the Sleep Number® modular base, please see the Assembling Your Base guide for assembly instructions.

Assembling Your Mattress .....	pg 4
Getting Comfortable with Your Sleep Number® Setting .....	pg 12
Product Care .....	pg 14
Frequently Asked Questions .....	pg 15
Important Information.....	pg 17
Welcome to Sleep Number InnerCircle® .....	pg 18
Sleep Number® Bedding Collection .....	pg 19
Warranty .....	pg 20

# Getting Started

**Decide where to put your new bed.** Make sure there's an electric power source nearby to operate your Firmness Control™ system. Assemble your modular base or existing bed frame before assembling your mattress.

**Prepare your bed.** To achieve the best comfort and support on your Sleep Number® mattress, a firm flat surface such as the Sleep Number® modular base, a solid surface platform bed or bunkie board is recommended. Assemble your modular base or existing bed frame before assembling your mattress.

**Prepare your foam comfort layer(s).** Foam comfort layer(s) should be stored at room temperature for at least four hours before mattress assembly. Carefully open the foam comfort layer(s) and set aside. They'll need at least 30 minutes to fully expand.

**Open all boxes.** CAUTION: Immediately dispose of packaging as it can pose choking or other hazards to small children and pets.

**WARNING:** Read all instructions before use to avoid injury. Improper use of product can result in serious injury or death. Follow the safety information in this assembly guide. Keep this assembly guide for future reference.



# Before You Begin

## Assembling Your Mattress

**Carefully check the contents of your mattress boxes.**

Make sure you have the correct number of components for the size of bed you purchased. If you are missing any items listed to the right, please call 1.800.472.7185 or email Customer Service at [customerservice@selectcomfort.com](mailto:customerservice@selectcomfort.com).

### CAUTION

Shock hazard. Firmness Control system is not water resistant. Do not use or store near water.

## Individualized Comfort

Our most advanced Sleep Number® DualAir™ technology allows you to find your Sleep Number® setting, name your side of the bed and more – all at the simple touch of a button.

## Mattress: What's Included

	Twin Extra-Long/Full	Double*/Queen	King/California King
<b>Mattress Cover</b>	1	1	1
<b>Foam Border Walls</b>	4	4	4
<b>Foam Comfort Layer</b>	1	1	1
<b>Foam Base Pad</b>	1	1	1
<b>Air Chambers</b>	1	2	2
<b>Firmness Control™ System</b>	1	1	1
<b>Corner Locks</b>	0	4*	0

# Mattress Components

Mattress Cover



Foam Border Walls



Two long and two short

Air Chambers

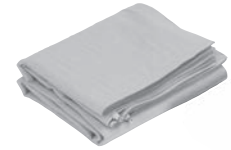

Corner Locks

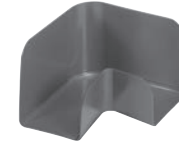

Double beds only

Foam Comfort Layer



Shown as packaged

Foam Base Pad

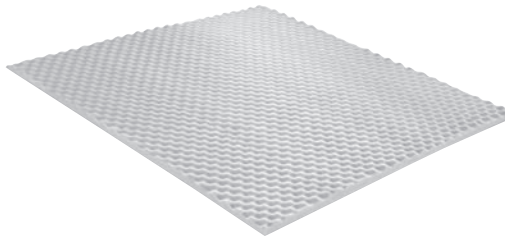

Firmness Control™ System



Remote

Remote may vary

Some texture and surface appearances may vary from those shown.

# Assembling Your Mattress

## 1 Mattress Cover

- Place on base or on existing bed platform, making sure openings in the bottom of the mattress cover are at the head of the bed.
- Unzip mattress cover at zipper A (see below).
- Set top of mattress cover aside.



## 2 Foam Side Walls

- Place long border walls along inside of mattress cover, extending the entire length of the bed.
- Make sure that the notches are facing the center of the bed.

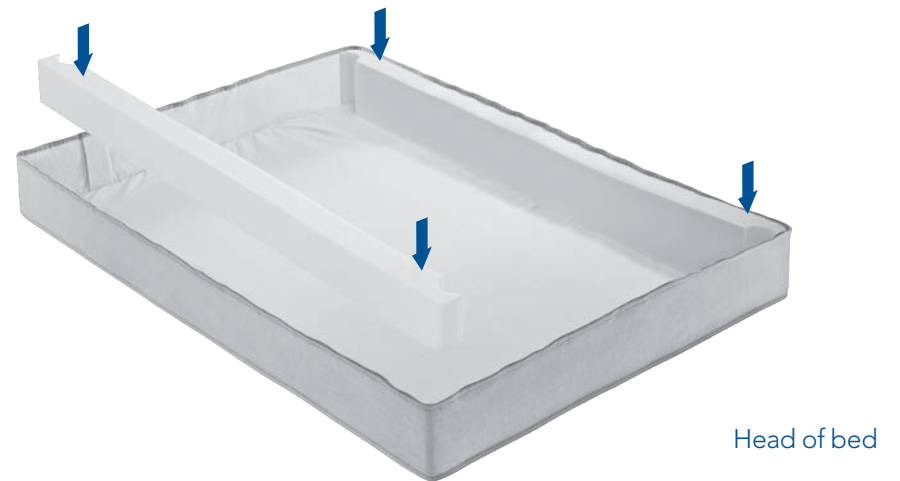

### Double Beds Only - Corner Lock™ System Assembly

- Place one corner lock in each corner of the mattress cover bottom.

IMPORTANT: Corner locks must be positioned under the border wrap.

- As you install the foam side and end walls, be sure the walls meet inside the corner locks at each corner. (Double beds use corner locks in place of notched side walls.)



### 3 Foam End Walls

- Place short border walls at the head and foot, between the side walls.
- Make sure the foam border walls are connected securely and squarely.
- Ensure that the zipper is aligned with the top edge of the foam border walls.

NOTE: It is okay if the foam walls bow to the inside of the bed at this point in the assembly.

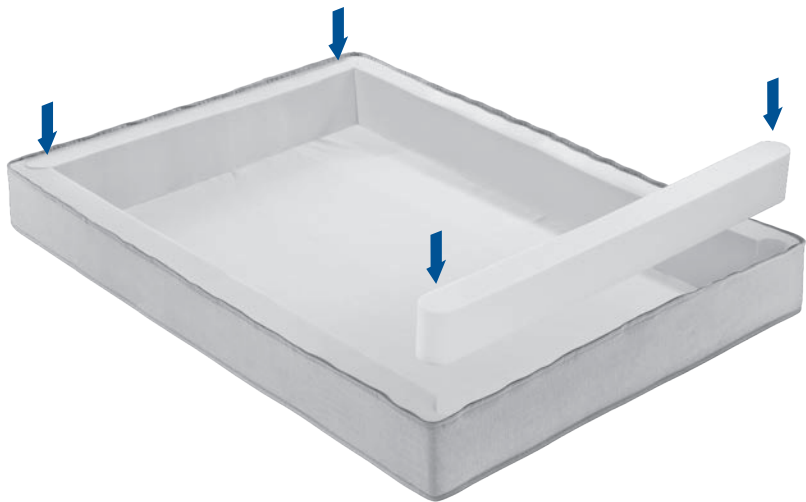

Head of bed

### 4 Foam Base Pad

- Carefully shake out the pad.
- Place the foam base pad in the bottom of the mattress cover with the smooth side facing down.



Head of bed

## 5 Air Chamber(s)

- Place air chamber(s) on top of foam base pad so the hose connectors face the head of the bed and lie on the bottom when inflated.
- Zip air chambers together.

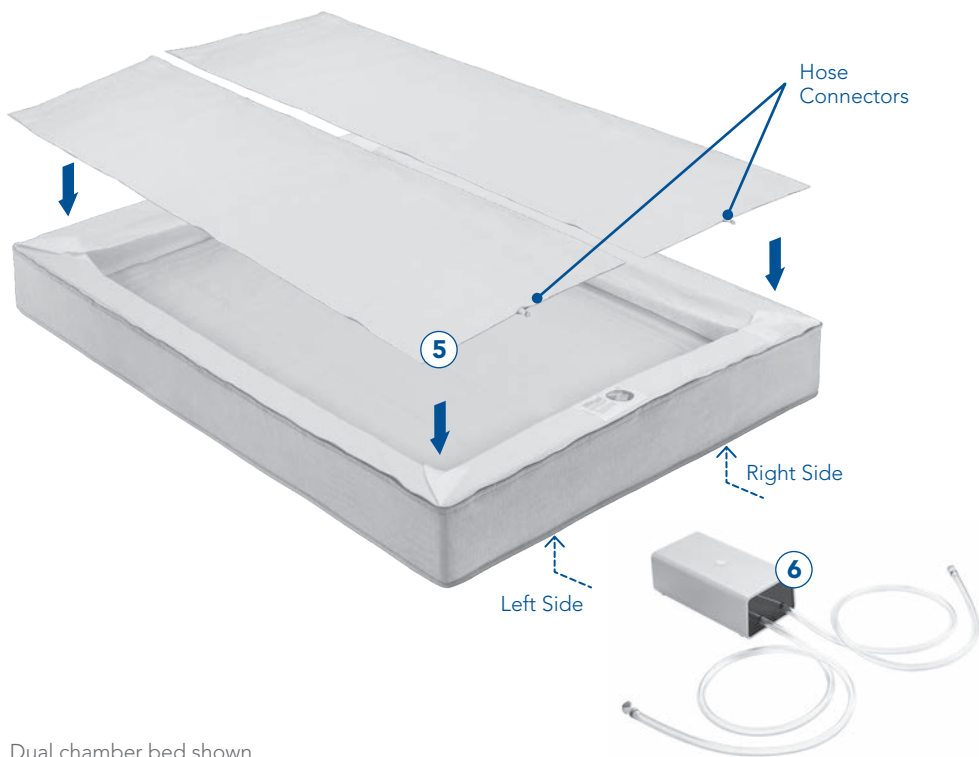

Dual chamber bed shown.

CAUTION: Firmness Control system has no user serviceable parts. Do not open.

Head of bed

## 6 Firmness Control™ System

### Firmness Control™ System for Dual Chamber Beds

- Pass the left Firmness Control™ system hose (marked with a white band) through the opening on the bottom left side of the mattress cover.
- Connect the Firmness Control™ system hose to the left air chamber by pushing together until you hear a click.
- Repeat for the right side of the mattress, using the right Firmness Control™ system hose (marked with a blue band).

### Firmness Control™ System for Single Chamber Beds

- Pass the Firmness Control™ system hose through the opening on the bottom of the mattress cover.
- Connect the Firmness Control™ system hose to the air chamber by pushing together until you hear a click.

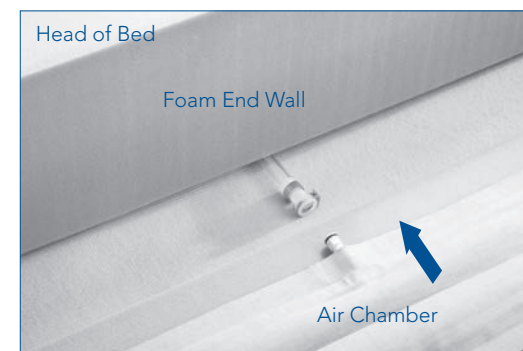



## DualAir™ Technology Inside

At the heart of the Sleep Number® bed is our most advanced DualAir™ technology. Adjustable air chambers and a Firmness Control™ system allow you to easily find your ideal level of comfort and support on each side — your Sleep Number® setting. See Remote Quick Start Guide for more details.



### Your Remote at a Glance

Low Battery Indicator

Up/Firmer

Down/Softer

My Sleep Number® Setting Button

Left/Right Button

Enter

Remote may vary.

## 7 Activate DualAir™ Technology

- Plug your Firmness Control™ system into a working electrical outlet.
- Insert two AA batteries (included) into your remote.
- Your remote will turn on simply by picking it up or pressing any button. Easy-to-follow instructions will guide you through the next steps.
- Please wait while your mattress inflates. This will take a few minutes. When complete, you'll be prompted to complete your bed assembly.

## 8 Border Wrap

- Extend the border wrap over the foam border walls as shown below.

Important Safety Notice: To ensure compliance with federal flammability requirements, the border wrap must be positioned correctly within the mattress as shown.



## 9 Duvet Cover

- Reattach mattress cover at zipper A.
- Remove mattress cover top at zipper B and set aside.

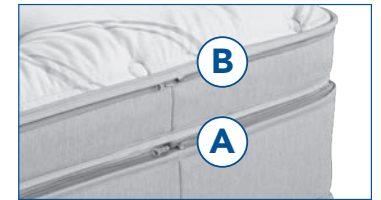

Head of bed

## 10 Foam Comfort Layer

- Place the foam comfort layer on top of the duvet cover. Make sure the smooth side of the foam faces down.



Foam pattern varies by bed model.

Head of bed

## 11 Border Wrap

- Extend the border wrap over the foam comfort layer as shown below.

Important Safety Notice: To ensure compliance with federal flammability requirements, the border wrap must be positioned correctly within the mattress as shown.



Head of bed

## 12 Mattress Cover Top

- To close mattress cover, place it on the bed with the zipper pull at the head of the bed.
- Make sure the zipper pin is completely inserted into the zipper box. Zip the top of the mattress cover closed.

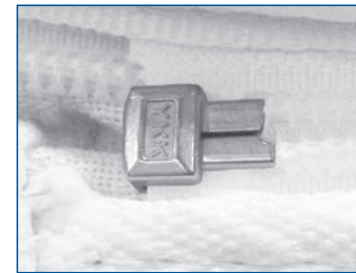

Proper zipper alignment



You're Done!

# Getting Comfortable with Your Sleep Number® Setting

There's nothing quite like finding your Sleep Number® setting—that moment when your body feels aligned, relaxed and perfectly supported. Your Sleep Number® remote is designed to easily guide you to your ideal level of firmness, comfort and support.

Begin by lying on the bed in your preferred sleeping position. Press  to choose your side of the bed. Press  and choose Sleep Number®. Press  and choose Find Sleep Number®. Follow the instructions on your remote to find your favorite Sleep Number® setting. This may take a few minutes.

## Give It Time

Don't worry if your bed doesn't feel "exactly right" at first. Try a Sleep Number® setting that feels the most comfortable for at least five nights. Then, evaluate your comfort. Make small adjustments until you've found the setting that feels most comfortable for you.

If you need additional assistance, visit [sleepnumber.com](https://sleepnumber.com) and click on Customer Service or call 1.800.472.7185 to reach a Customer Service Representative. Our trained Customer Service Representatives will provide help to improve your comfort.

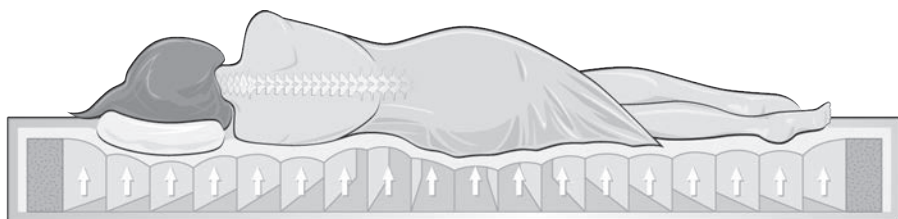

Right

- Neck and back are aligned in the same position as when you are standing
- No discomfort at shoulder and hip pressure points
- You feel the mattress support the small of your back (back sleepers) or the curve of your side (side sleepers)

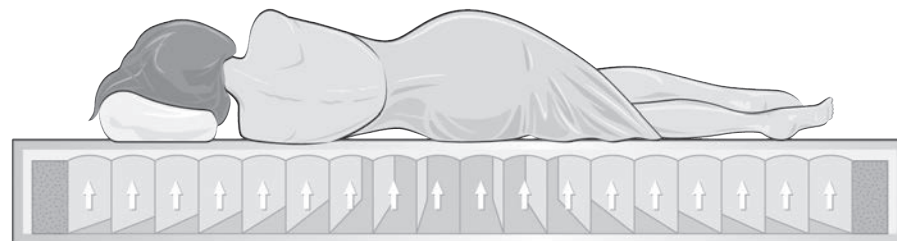

Wrong

- Body alignment is not straight
- Your pillow makes your head tilt at an angle from the rest of your body
- You feel discomfort from pressure at your neck, shoulders, back, hips or legs

## Things to Remember

The best part about your Sleep Number® bed is that it's adjustable every day, as your comfort needs change.

Reasons you may wish to adjust the firmness of your bed:

- strained muscles
- back pain
- weight change
- pregnancy
- sunburn
- new sleeping position

## Tips for a Great Night's Sleep

Not getting 8 hours of sleep a night? Don't despair.

These tips from the experts at Sleep Number can help you fall asleep more easily and sleep more soundly.

- Keep a regular sleep schedule, even on the weekends.
- Avoid TVs, computers, phones and tablets before bedtime.
- Exercise regularly, but not too close to bedtime.
- Eliminate caffeine after noon.

## Sleep Number® Setting Study

As you can see in the chart below, Sleep Number® bed owners find comfort at all settings from 5-100, however the majority of sleepers find their Sleep Number® setting between 35 and 50.

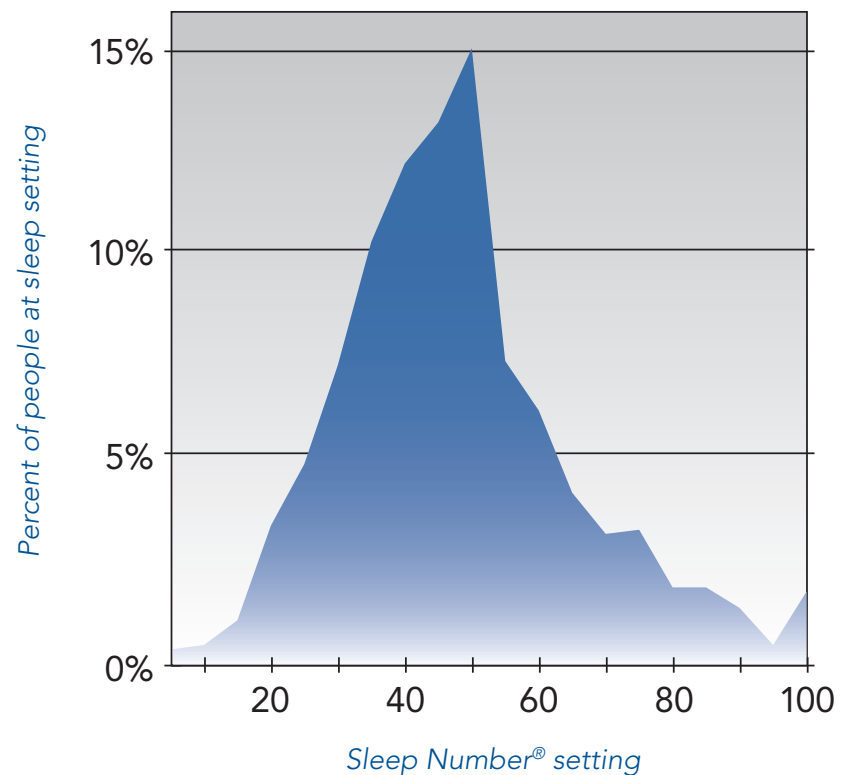

# Product Care

## Cleaning Your Mattress

Spot clean the cover of your Sleep Number® mattress with carbonated water. Do not dry clean the mattress cover or put it in a washing machine. Do not apply stain guard; it may cause the fabric to turn yellow.

Sleep Number® is an industry leader in the use of materials designed to inhibit the growth of allergens or microorganisms.

Advanced antimicrobial safeguards are incorporated into every Sleep Number® bed. Key components of the mattress have been treated to protect the bed from contaminants such as mold, mildew and bacteria growth. The unique, zip-open design of the Sleep Number® bed allows you to easily open, ventilate or vacuum if you choose.

In rare instances and under the right conditions, mold or mildew can form inside many types of mattresses, bedding or upholstered products. Should this condition occur in your mattress, please contact our Customer Service department at 1.800.472.7185 so we can work with you to return your bed to factory-fresh condition.

## Cleaning Your Remote

- Wipe the body with a clean cloth dampened with a mild soap and water solution.
- Wipe the display screen with a clean, dry, lint-free cloth  
CAUTION: Do not immerse in water or place in dishwasher.

## Moving Your Sleep Number® Bed

- Always disassemble the base. Bag all hardware so that it is not lost.
- The mattress can be fully inflated, capped off and packaged in a mattress box for moving.
- If you don't have a mattress box, double-bag the cover to prevent stains. Deflate and box the air chamber(s) to prevent possible damage.
- Pack the Firmness Control™ system in a box with packing material. Transport with minimal exposure to shock and vibration.
- Tuck the remote, air chamber caps and instructions in the box with the Firmness Control™ system to prevent them from being lost.

# Frequently Asked Questions

## Mattress FAQs

**Q. Where are the air chamber caps? And where should I store them?**

A. The caps are in the Firmness Control™ system box. Please store these in the mattress cover at the head of the bed in case you should ever need to temporarily cap your air chamber(s).

**Q. What if my foam comfort layer appears to be too small or irregular?**

A. Gently shake the layer as you place it in your mattress and it will recover its full size overnight.

**Q. What if I feel like I'm rolling toward the edge or toward the center of the mattress?**

A. Although rare, these sensations could potentially be experienced if one side of the mattress is set quite firm and the other side quite soft. Call Customer Service at 1.800.472.7185 for a remedy to this situation if bothersome to you.

**Q. What if I notice a rubber smell from the air chamber(s)?**

A. The odor you may smell is non-toxic and will fade over time. To minimize the smell, unzip the mattress cover and allow the air chamber to air out for a few hours. Laying a couple of dryer sheets on top of the air chamber will also help mask any odor by adding a fresh scent.

## Firmness Control™ System FAQ's

**Q. Why does my Sleep Number® setting change?**

A. Your Sleep Number® setting is based on the combination of body weight, volume of air in the air chamber and sleep position. Several factors may contribute to fluctuations in your Sleep Number® setting:

- Temperature can cause changes in your Sleep Number® setting. For example, a heated mattress pad will cause the Sleep Number® setting to increase.
- Barometric pressure related to weather and altitude can cause your Sleep Number® setting to change.
- Weight can affect your Sleep Number® setting. The Firmness Control™ system acts similarly to a scale. More weight means a higher Sleep Number® setting.
- Different sleep positions can affect your Sleep Number® setting. The more concentrated the weight is, the greater chance the Sleep Number® setting will be higher (e.g., when you lie on your side). When weight is distributed more evenly throughout the chamber, it is more likely that the Sleep Number® setting will be lower (e.g., when you lie on your back or stomach).

**Q. What do I do if the Firmness Control™ system doesn't run?**

A. Make sure the power cord is securely plugged into the Firmness Control™ system. Verify that the power cord is plugged into an outlet that has power and is not connected to a wall switch.

**Q. I feel the mattress is losing air. What should I do?**

A. Air loss can be caused by an unsecured hose connection, a defective air chamber or a defective Firmness Control™ system. First, make sure the hoses are securely connected to the air chambers. If you do not find any

damaged or loose connections, identify which of the following situations matches your situation and follow the instructions for remedying your issue.

NOTE: To avoid variations in your Sleep Number® setting or level of comfort, make sure that you are lying in your preferred sleep position when adjusting and checking your Sleep Number® setting.

If you have a dual air chamber bed and suspect only one side of your Sleep Number® bed is getting softer:

- Inspect the o-ring and connectors for cracking or damage.
- Switch the hoses on the air chambers so the left hose (marked with a white band) is attached to the right air chamber and the right hose (marked with a blue band) is attached to the left air chamber. You should hear a click when the hose is securely connected to the air chamber.
- Fill the air chambers to the appropriate Sleep Number® setting(s) for the person sleeping on each side of the bed.
- Sleep on the bed and monitor the feel of the bed's firmness on both sides.
- If neither chamber feels softer over time, you may have had a loose connection that was fixed when the hoses were switched. Switch the hoses back to their correct positions and continue to use the bed as usual.
- If an air chamber feels softer after switching hoses, contact Customer Service with the results (the issue stayed on the same side of the bed or it moved to the other side after switching hoses).

If you have a dual air chamber bed and both air chambers are getting softer or you have a single air chamber bed and feel the air chamber getting softer:

- Inspect the o-ring(s) and connector(s) for cracking or damage, then reconnect the Firmness Control™ system to the air chamber(s).
- Lie down in your normal sleep position and fill the air chamber(s) with suspected air loss to your normal Sleep Number® setting

plus an additional 15 points (e.g., if you sleep at 35, fill to 50). Over-inflation will compensate for air that may escape in one of the next steps.

- Locate the air chamber cap(s) that came with your bed.\*
- Disconnect the hose(s) from the air chamber(s) and quickly cap the chamber(s).
- Leave the air chamber(s) capped for a minimum of 48 hours.
- If the air chamber(s) become noticeably softer when capped, contact Customer Service.
- If the air chamber(s) hold air, reconnect the hose(s) and continue using the bed. The air loss issue may have been due to environmental factors or a connection issue. Contact Customer Service if the air loss issue returns after reattaching the Firmness Control™ system.

\*Air chamber caps are typically found at the head of the bed inside the mattress cover in a small plastic bag. If you cannot find the caps, they may be available at your nearest Sleep Number® store. You can also request them by emailing Sleep Number® at [CustomerService@selectcomfort.com](mailto:CustomerService@selectcomfort.com) with your request or by calling 1.800.472.7185.

Q. Will my bed deflate if there is a power surge or power loss?

A. No, your mattress will maintain its firmness.

Q. How will I know if there's a problem, like the chamber isn't inflating or the system isn't receiving power?

A. The remote is designed to let you know if something isn't working like it's supposed to. An error message will let you know an issue has been detected, along with prompts for how to fix it. If the error is still not resolved, you will be instructed to visit [sleepnumber.com/chat](http://sleepnumber.com/chat) or to call us at 1.800.472.7185.



## Remote Control FAQs

Q. How do I capitalize a letter in the middle of my name?

A. Select the letter and press   simultaneously.



Q. How many characters can I use for my name?

A. Eleven.

Q. My remote says there's an inflation/connectivity error. What should I do?

A. An error message lets you know an issue has been detected, along with prompts for how to fix it. If the error is still not resolved, you will be instructed to visit [sleepnumber.com/chat](https://sleepnumber.com/chat) or to call us at 1.800.472.7185.

Q. How do I restore the remote's original settings?

A. To erase all stored information, hold down all three buttons (Up/Down/Enter)    simultaneously for seven seconds.

Q. Why won't my remote turn on?

A. You may need to replace the batteries. Your remote comes with two AA batteries that should last about six months with normal use. If new batteries don't resolve the issue, please visit [sleepnumber.com/chat](https://sleepnumber.com/chat) or call us at 1.800.472.7185.

## Important Information

### FCC Compliance

The equipment described in this guide has been tested and found compliant with the limits for a Class B digital device, pursuant to Part 15 of the FCC rules. These limits are designed to provide reasonable protection against harmful interference when the equipment is operated in a commercial environment. This equipment generates, uses, and can radiate radio frequency energy and if not installed and used in accordance with the instruction manual, may cause harmful interference to radio communications. However, there is no guarantee that interference will not occur in a particular installation. If this equipment does cause harmful interference to radio or television reception, which can be determined by turning the equipment off and on, the user is encouraged to try to correct the interference by one or more of the following measures:

- Reorient or relocate the receiving antenna.
- Increase the separation between the equipment and receiver.
- Connect the equipment into an outlet on a circuit different from that which the receiver is connected.
- Consult the dealer or an experienced radio/TV technician for help.

WARNING: Any attempt to make changes or modifications could void the user's authority to operate the equipment according to FCC certification.

### Important Safety Instructions

- Your Sleep Number® bed is intended for in-home, non-commercial use only. Any unintended use voids the limited warranty.
- The remote is not a toy and should be used under adult supervision.
- Do not open the Firmness Control™ system or remote(s) (with the exception of the battery compartment). The warranty is void if these units are tampered with. The Firmness Control™ system has no user serviceable parts.
- Keep the Firmness Control™ system and remote(s) away from heat sources such as radiators, heat registers, etc.
- Firmness Control™ system and remote(s) are not water resistant. Do not use or store near water — for example, in a wet basement, near an open window, etc.

### Replacement Components

In the event that replacement components are required or if you wish to upgrade to newer components that are not covered in the warranty, you may purchase these items by simply providing proof of purchase. All component sales are final and carry a 2-Year Limited Warranty from the purchase date. Product discounts and bedding promotions do not apply to components. For current pricing and to process a component purchase, call our Customer Service department at 1.800.472.7185.

# Welcome to Sleep Number InnerCircle<sup>®</sup>

Congratulations on the purchase of your Sleep Number<sup>®</sup> bed. As a Sleep Number<sup>®</sup> bed owner you are now an Insider, a member of our InnerCircle.<sup>SM</sup> Soon you'll be enjoying all the benefits of a better night's sleep on your new Sleep Number<sup>®</sup> bed.

## Enjoy Your Insider Benefits Today

### **Go to [sleepnumber.com/innercircle](https://sleepnumber.com/innercircle)**

With your order number from your receipt, you can unlock your Insider account to access all your InnerCircle.<sup>SM</sup> benefits online. You'll also find pass-along coupons to share with friends and family, and everyone you know who could use a better night's sleep.

### **Receive special savings.**

Throughout the year, we'll send you Insider-exclusive offers on beds and bedding.

### **Earn rewards.**

Share what you love about your Sleep Number<sup>®</sup> bed with friends and family and receive a \$100 reward each time someone you've referred buys a bed. When your 10th referral buys a bed, you'll receive an additional \$799! Reward certificates can be used toward a Sleep Number<sup>®</sup> bed or for anything in our Bedding Collection.

### **Be the first to know.**

As an Insider, you'll be the first to know about our latest innovations, from new Sleep Number<sup>®</sup> beds to bedding solutions that will improve your sleep.



Sleep Number®

# Bedding Collection

Sleep your best with the Sleep Number® Bedding Collection. From temperature balancing innovations to pillows individualized for you, discover bedding designed to meet your unique comfort needs.

- DualTemp™ layer and other temperature balancing innovations
- PillowFit® expertise to find just the right pillow for you
- Quality sheets designed for luxurious comfort
- Comforters for year-round cozy warmth

## Experience PillowFit®

Our Sleep Professionals will use PillowFit® expertise to find the firmness, fill and fit for you. Only at a Sleep Number® store.



Too high



Too low



A good fit

# Help is just a click or phone call away.

If you ever have questions or need help finding your ideal comfort, please visit us at [sleepnumber.com/chat](https://sleepnumber.com/chat) to chat with a live representative 7 a.m. – 11 p.m. (Central Standard Time) daily or call [1.800.472.7185](tel:18004727185)

Representatives are available by phone  
(Central Standard Time):

Monday-Friday	8 a.m. – 8 p.m.
Saturday	8:30 a.m. – 5 p.m.
Sunday	Closed

**Warranty:** For warranty details please visit [sleepnumber.com/warranty](https://sleepnumber.com/warranty) or call [1.800.472.7185](tel:18004727185).



9800 59<sup>th</sup> Avenue North, Minneapolis, MN 55442



120662

©2016 Select Comfort Corporation

7/16 207541