

sleep  number®

Signature Series q3 Bed Assembly Guide



Welcome and Congratulations

Congratulations on your purchase of a SLEEP NUMBER® bed! You're about to join the nearly 8 million people who've traded their innerspring mattresses for the most innovative sleep surface ever. The technology behind the *Sleep Number* bed is one that recognizes the unique sleeping needs of every individual, which vary according to comfort preference, body type, height, weight, sleeping position, and other health and lifestyle factors. By creating a fully personalized sleep surface, your new *Sleep Number* bed offers you customized comfort that can significantly improve your sleep quality.

You'll enjoy years of the latest generation of sleep comfort and technology in your *Sleep Number* bed. Our commitment to quality is at the heart of our manufacturing process and every *Sleep Number* bed is designed and crafted in the USA. Our focus on constant innovation, value and customer satisfaction has repeatedly earned us the Consumers Digest Best Buy award.

We thank you for your purchase and wish you years of personal comfort and restful sleep.

Dear QVC Customer,

Congratulations! We are delighted that you purchased the SLEEP NUMBER® bed. We know you will enjoy your *Sleep Number* bed for many years!

QVC and SLEEP NUMBER are committed to providing exceptional service to you. To provide that priority service, we have established the Sleep Number® GOLD SERVICE program with a phone number, 1.800.790.9298, exclusively for QVC customers. This number will allow you to quickly reach a SLEEP NUMBER® representative.

These *Sleep Number* representatives are product specialists who are able to answer any questions you may have regarding setup, finding your SLEEP NUMBER® setting, manufacturer's warranty details, or any other product-related questions—including comfort tips. When you call, please have your QVC Order Number readily available. *Sleep Number* representatives are available Monday through Friday, 8 a.m. to 6 p.m. CST and Saturday, 8:30 a.m. to 5 p.m. CST. You can also visit the SLEEP NUMBER® customer website at mygoldservice.com, where you will find assembly information, troubleshooting FAQs and warranty information.

For all other questions, please contact QVC Customer Service at 1.800.367.9444 or visit qvc.com/customerservice. Thank you for your purchase. QVC and *Sleep Number* look forward to serving you in the future.

Sleep Well!

Assembly Video

For a step-by-step demonstration on how to assemble a SLEEP NUMBER® bed, watch this video.

Models may vary. For instructions specific to your bed, please follow printed assembly steps.

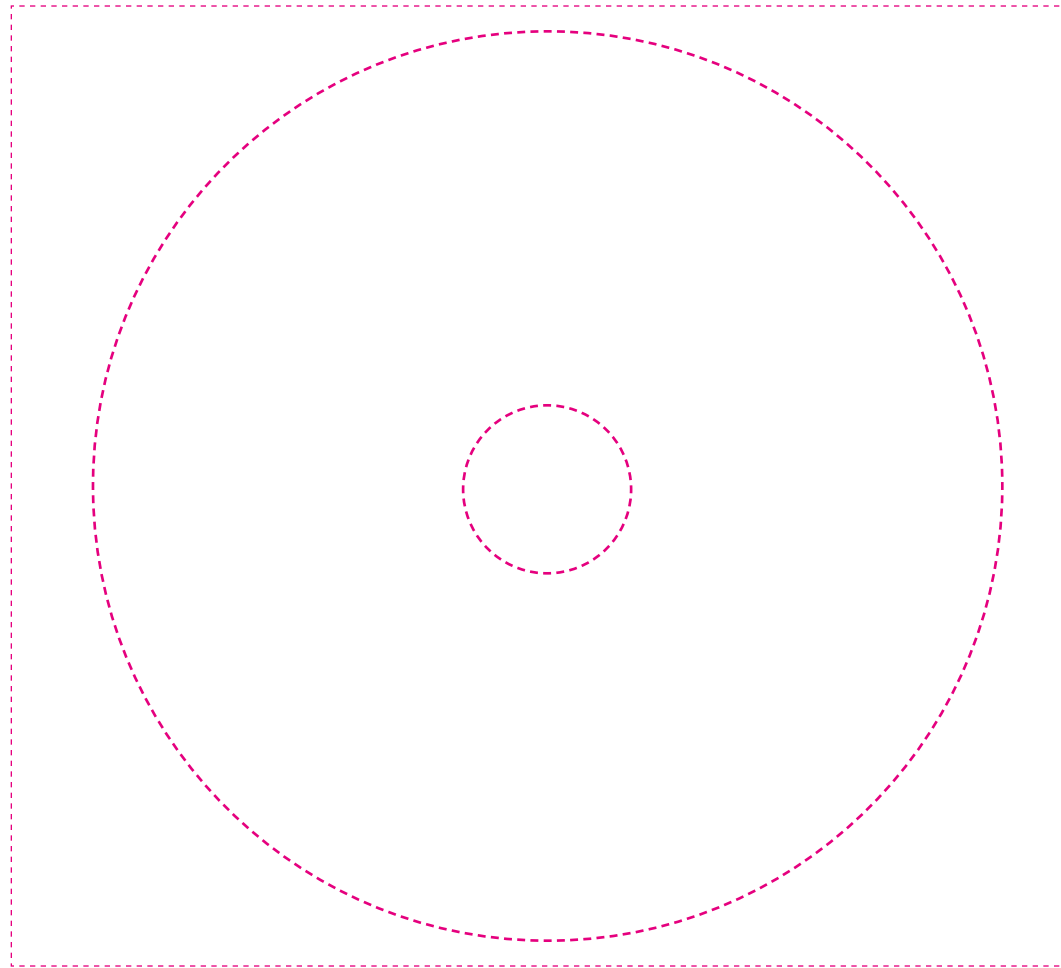

What's Inside

Setting up your new SLEEP NUMBER® bed only takes about an hour, but you'll enjoy the benefits of better sleep for years to come. You won't need any tools and, although it's nice to have a helper, you can do it by yourself. First, you'll need to remove your old bed.

Base Assembly	pg 6
Mattress Assembly.....	pg 12
Firmness Control™ System	pg 20
Product Care	pg 23
Warranty and Notification.....	pg 24
Frequently Asked Questions	pg 26



Important

- Decide where to put your new bed
- Make sure there's an electric power source nearby to operate your Firmness Control™ system
- IMPORTANT:** Use a surge protector

While the Firmness Control™ system may be plugged directly into a wall outlet, we recommend using a surge protector to guard against unexpected power surges. Please note: Your 20-Year Limited Warranty does not cover damage to the Firmness Control™ system due to a power surge, regardless of the source. See the Limited Warranty on page 25 for more details.
- Open all boxes

CAUTION: Immediately dispose of packaging as it can pose choking or other hazards to small children and pets.
- IMPORTANT NOTE:** Prepare your foam pad
 - Locate box with foam comfort pad
 - Carefully open the foam comfort pad and set aside. At least 30 minutes of expansion time is needed
- Firmness Control™ System
 - Locate box with Firmness Control™ system
 - Set Firmness Control™ system aside. It will be required later during base assembly

Before You Begin Your Base Assembly

- Carefully check the contents of your base boxes
 - Verify that you have the number of components required for the size of bed you purchased (see Base Parts and Components list on the following page)
 - If you are missing any items listed on the following page, please call 1.800.790.9298 or email Customer Service at customerservice@selectcomfort.com
 - Familiarize yourself with all of the parts by comparing them to the images on the following page

Prepare your bed frame, if you have one

Your base can be assembled directly onto your current bed frame or on the floor. Some bed frames have slats that run from one side of the bed to the other. If your bed frame has slats, position the slats evenly to support the base. If your bed frame has fewer than three slats, we recommend adding additional slats to ensure adequate support for your base.

NOTE: Be sure the size of your base corresponds to the size of your bed frame. To ensure adequate support, check your frame for center support. If the frame does not have center support, we recommend the use of bed slats.



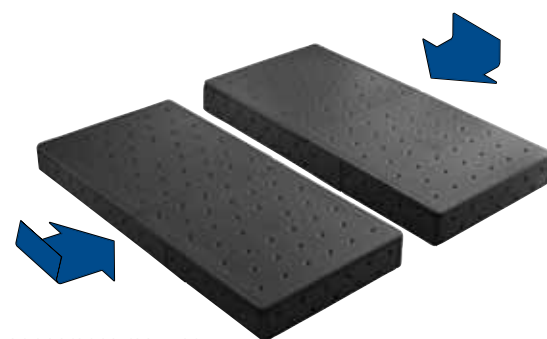

King bases

King and California King bases consist of two bases side by side, as shown below. Complete the assembly of one unit, assemble the second, then place side by side on the bed frame.

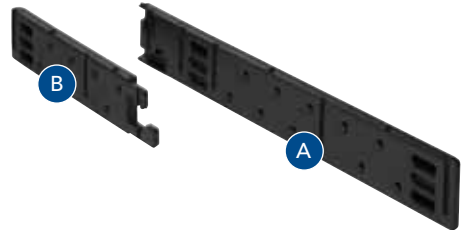
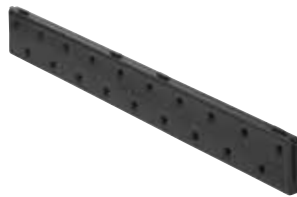
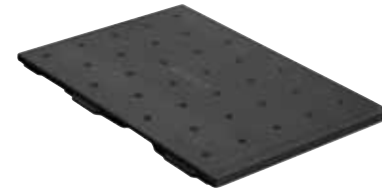

Note: Texture and surface appearance may vary.

Base Parts and Components

	Full	Queen	King/ California King
Side Rails Texture and surface appearance may vary 	2 each	2 each	4 each
Support/End Beams Texture and surface appearance may vary 	6 2 labeled "End Beam" 4 labeled "Support Beam"	6 All labeled "Support Beam"	12 King: all labeled "Support Beam" California King: 4 labeled "End Beam" 8 labeled "Support Beam"
Deck Panels Texture and surface appearance may vary 	4	4	4
Pin Components 	2	2	4
Coverlet Packaged in the mattress box Shown as packaged 	1	1	1
Firmness Control™ System Remote will vary 	1	1	1

If you are missing any items listed above, please call 1.800.790.9298 or email Customer Service at customerservice@selectcomfort.com.

1 Side Rails

- Connect the components labeled A side rail and B side rail together
- Make sure a shorter side rail is paired with a longer side rail for each connection; push firmly; joints fit tightly

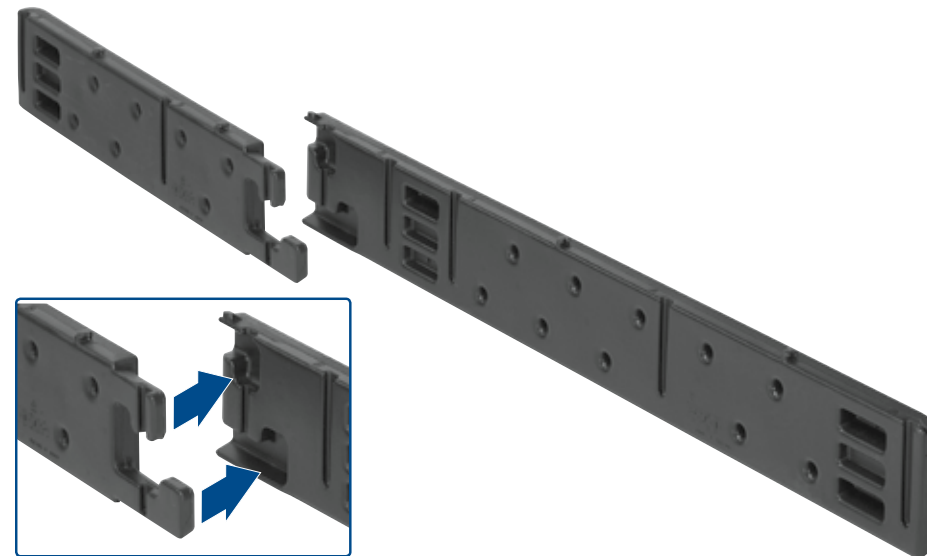

2 Pins

- Insert pins by sliding into side rails in the direction of the arrow
- Push firmly
- Make sure that the top of the pin is flush with the top of the side rail as shown in image "B" below

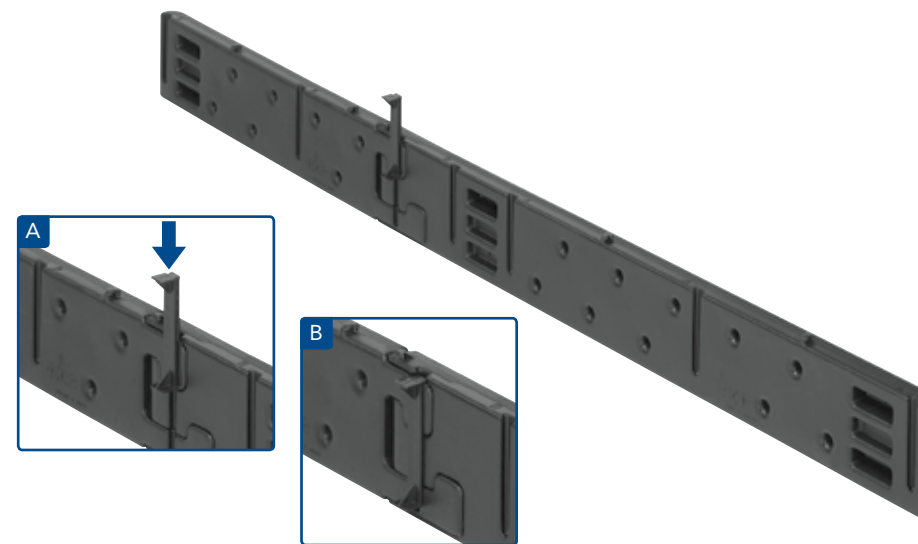

3 Support/End Beams

Match "A" end of the support/end beam with the "A" groove of the side rail. Match "B" end of the support/end beam with the "B" groove of the side rail

For Queen and King beds:

- Slide one of the beams labeled "support beam" into the end of the side rails at the head of the bed, ensuring the tabs are pointed up; push firmly until top is flush; joints fit tightly
- Slide remaining support beams into grooves of the side rails, beginning at the head of the bed and progressing toward the foot. Be sure to match the "A" end of the support beam with the "A" groove of the side rail and the "B" end of the support beam with the "B" groove of the side rail

For Full and California King beds:

- Slide one of the beams labeled "end beam" into the side rails ensuring the tabs are pointed up; push firmly until top is flush; joints fit tightly at the head of the bed
- Slide support beams into grooves of the side rails, beginning at the head of the bed and progressing toward the foot. Be sure to match the "A" end of the support beam with the "A" groove of the side rail and the "B" end of the support beam with the "B" groove of the side rail
- Slide remaining beam labeled "end beam" into the grooves at the foot of the bed

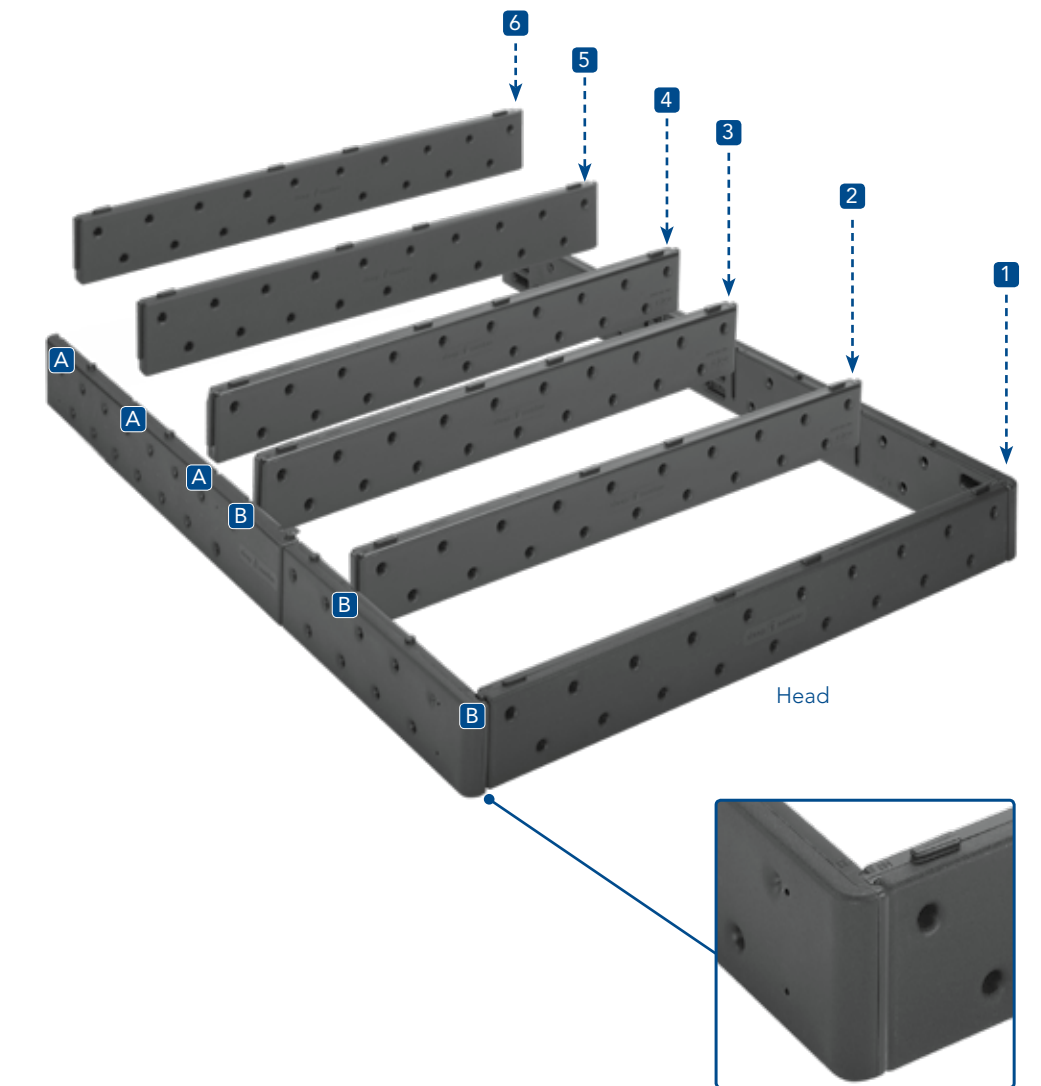

4 Firmness Control™ System

- Place the Firmness Control™ system under the base at the head of the bed with the hoses pointing in the direction of the head of the bed
CAUTION: If base is placed directly onto floor, place Firmness Control™ system next to the head of the base
- Plug the power cord into the Firmness Control™ system and into a surge protector
- Extend hoses in front of the head of the bed and toward their respective sides of the bed (for dual chamber beds) or to one side (for single chamber beds)

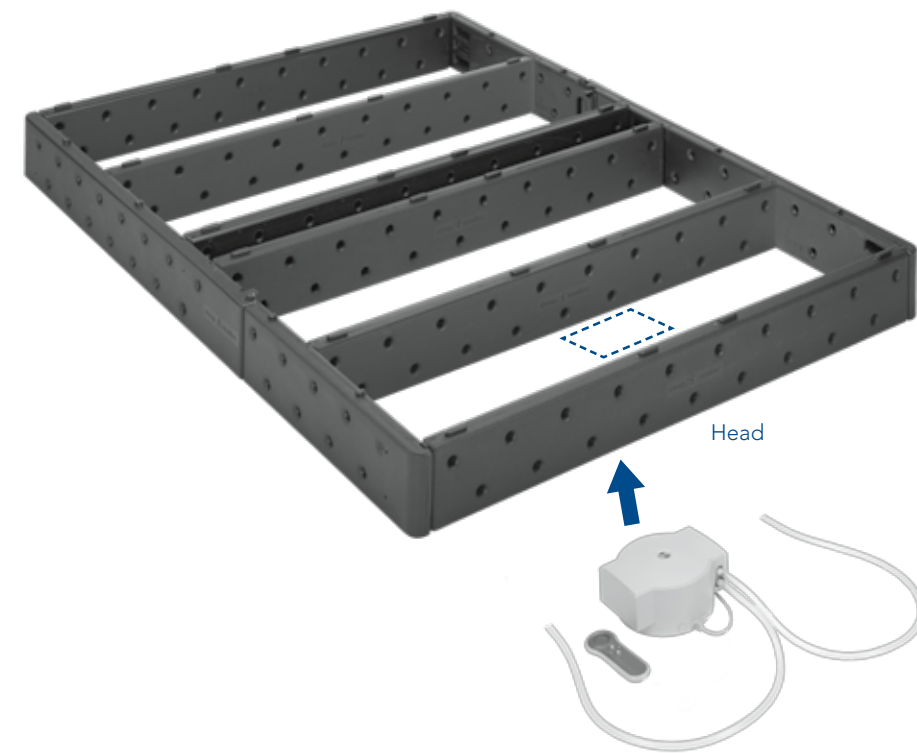

5 Deck Panels

- Slide deck panels onto frame from outside in, locking each deck panel into place by securing it to the tabs of the frame and beams
- Ensure the deck panels are flush on all sides
- Panels fit snugly; do not force

NOTE: King and California King bases consist of two bases, side by side.

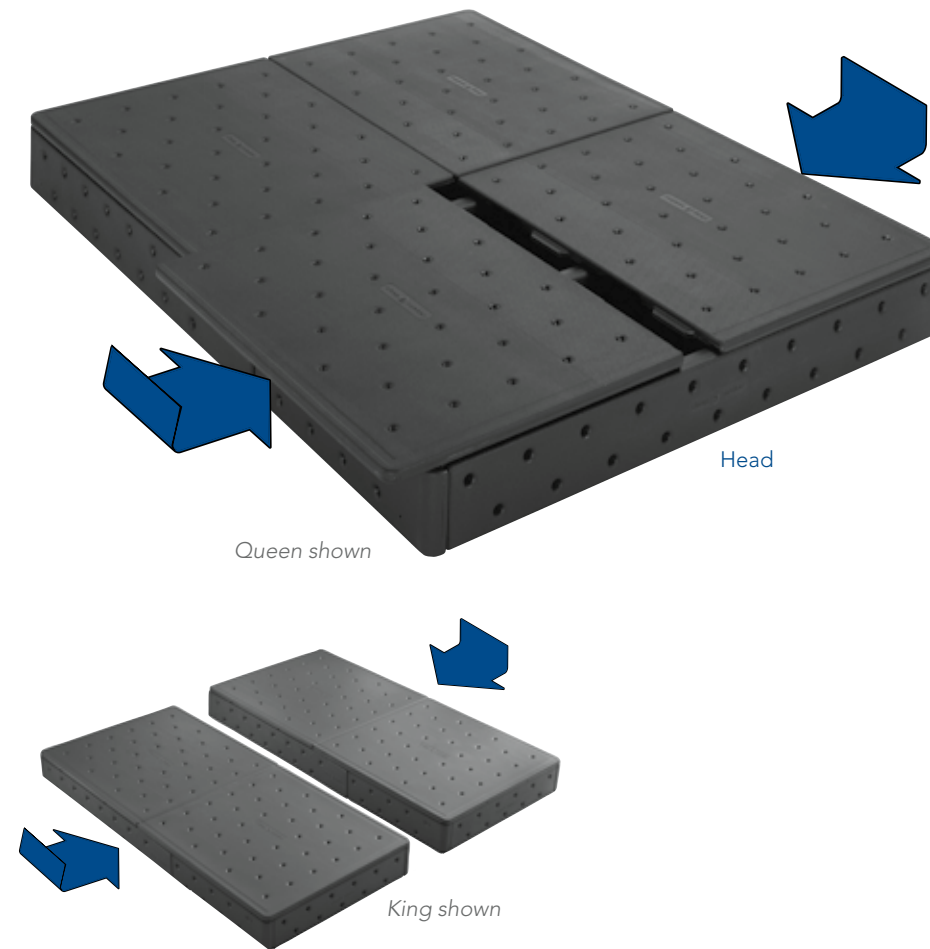

Note: Texture and surface appearance may vary.

6 Coverlet

- Place coverlet on top of base
- Carefully cover one corner at a time, positioning the seam at the head of the bed





Important

- Orientation
These instructions refer to “left” and “right” as if you are lying on your back on the bed looking toward the foot of the bed
- Open all boxes
CAUTION: Immediately dispose of packaging as it can pose choking or other hazards to small children and pets
- Carefully check the contents of your mattress boxes
 - a. Verify that you have the number of components required for the size of bed you purchased
 - b. If you are missing any items listed on the following page, please call 1.800.790.9298 or email Customer Service at customerservice@selectcomfort.com
- IMPORTANT: Use a surge protector. The warranty does not cover damage to the Firmness Control™ system due to a power surge. Using a surge protection device (not included) is recommended.
- NOTE: If you have not done so already
 - a. Firmness Control™ System
 - Place the Firmness Control™ system under the base at the head of the bed with the hoses pointing in the direction of the head of the bed (see page 10 for reference)
CAUTION: If base is placed directly onto floor, place Firmness Control™ system next to the head of the base.
 - Plug the power cord into the Firmness Control™ system and into a surge protector.
NOTE: For best results, do not plug surge protector into an outlet that’s controlled by a wall switch.
 - Extend hoses in front of the head of the bed and to their respective sides of the bed (for dual chamber beds) or to one side (for single chamber beds)

- b. Prepare your foam pad
 - Locate box with foam comfort pad
 - Carefully open the foam comfort pad and set aside. At least 30 minutes of expansion time is needed.
CAUTION: Immediately dispose of packaging as it can pose choking or other hazards to small children and pets.

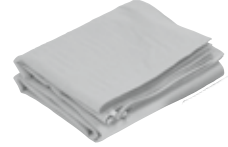

Mattress Parts and Components

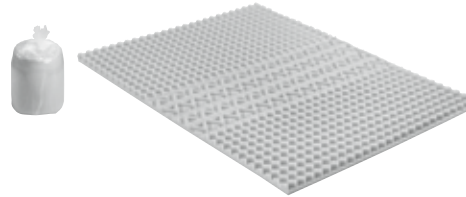
	Full	Queen/King/ California King	Split King
Mattress Cover Color and pattern will vary by bed Shown as packaged 	1	1	2
Foam Border Walls Two long and two short 	4	4	8
Air Chambers 	1	2 May be in one package	2 May be in one package
Firmness Control™ System with Remote Remote will vary 	1 1 remote included with single chamber beds	1 2 remotes included	1 2 remotes included
Center Foam Wall Dual Chamber beds only 	0	1	0
Foam Comfort Pad Color and pattern will vary by bed Shown as packaged 	1	1	2

Note: The warranty does not cover damage to the Firmness Control™ system due to a power surge. Using a surge protection device (not included) is recommended.

If you are missing any items listed above, please call 1.800.790.9298 or email Customer Service at customerservice@selectcomfort.com.

1 Mattress Cover

- Place mattress cover on base or on existing bed platform

NOTE: Make sure the holes in the bottom of the mattress cover are at the head of the bed.



2 Mattress Cover Top

- Unzip and set mattress cover top aside



3 Foam Side Walls

- Place long border walls along inside of mattress cover, extending the entire length of the bed.
- Ensure that the notches are facing the center of the bed

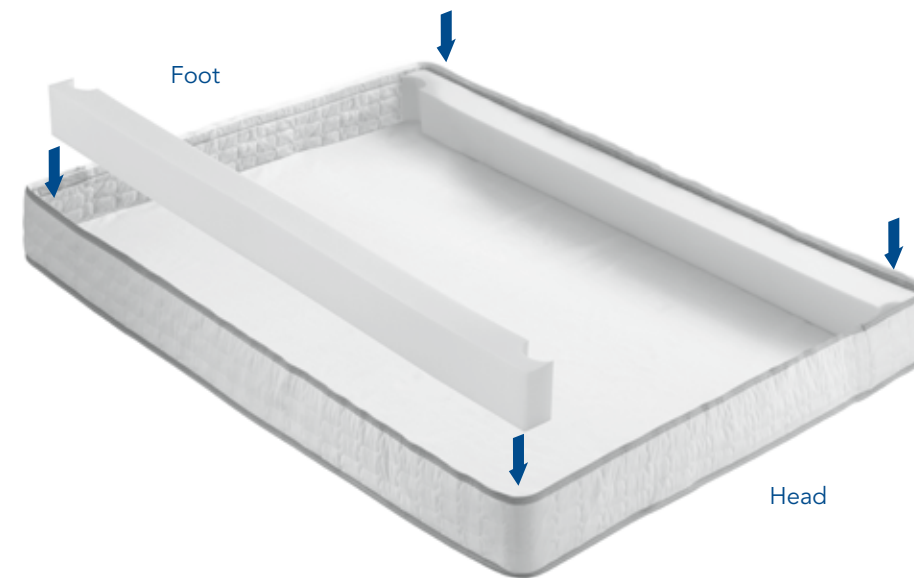

4 Foam End Walls

- Place short border walls at the head and foot inside the mattress cover, between the side walls
- Make sure the foam border walls are connected securely and squarely
- Ensure that the zipper is aligned with the top edge of the foam border walls

NOTE: It is okay if the foam walls bow to the inside of the bed at this point in the assembly.



5 Air Chamber(s)

- Place air chamber(s) in the mattress cover so the hose connectors lie on the bottom when inflated and the connectors face the head of the bed

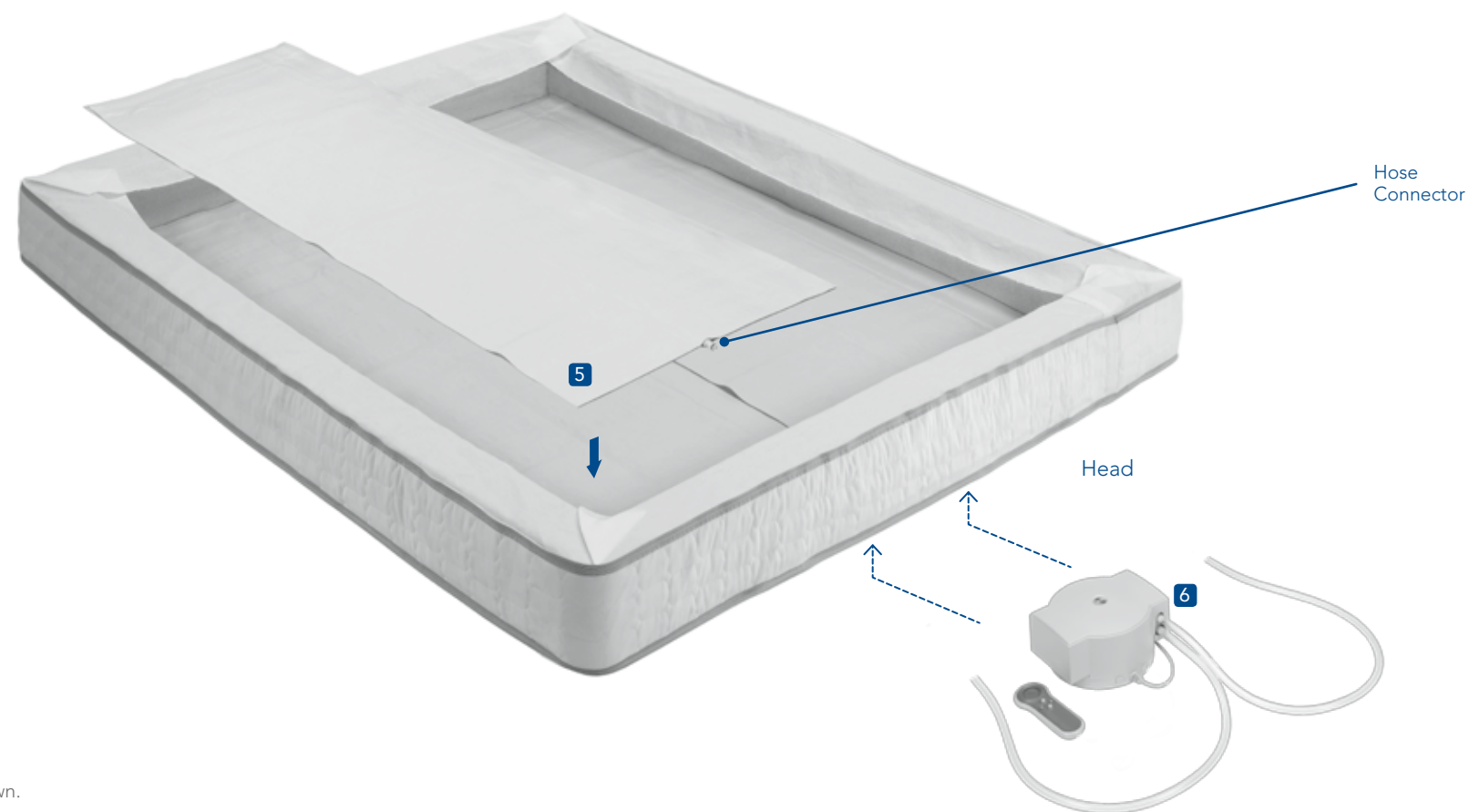

Dual chamber bed shown.

6a Firmness Control™ System for Dual Chamber Beds

- Locate the hoses for the Firmness Control™ system
- Pass the hose marked "L" through the opening on the left side of the mattress cover. Connect the hose to the left air chamber by pushing together until you hear a click. (Left is indicated as though you are lying on the bed, looking toward the foot of the bed)
- Repeat with the unmarked hose and remaining air chamber

To Calibrate:

- Press "L" or "R" to activate your remote, then choose a side.
- Press and hold the firmer ▲ button to begin inflating the mattress. Release the ▲ button to see the SLEEP NUMBER® setting. Stop once the *Sleep Number* reaches 20.
- Repeat steps 1 and 2 for the second chamber.

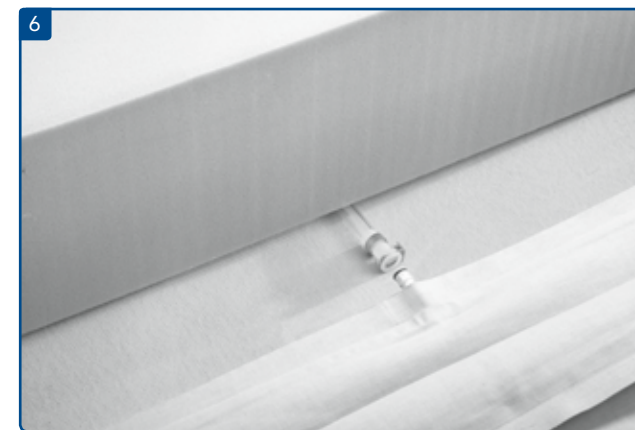

6b Firmness Control™ System for Single Chamber Beds

- Locate the hose for the Firmness Control™ system
- Pass the hose through the opening in the mattress cover and connect to the air chamber by pushing together until you hear a click

To Calibrate:

Press and hold the firmer ▲ button to begin inflating the mattress. Release the ▲ button to see the SLEEP NUMBER® setting. Stop once the *Sleep Number* reaches 20.



Store air chamber caps inside mattress at head of bed.

7 Center Foam Wall (Dual Chamber Beds Only)

- Insert center foam wall between the air chambers



8 Foam Comfort Pad

- Place the foam comfort pad on top of the air chamber(s)



9 Border Wrap

- Ensure that the border wrap extends over the foam comfort pad as shown below

Important Safety Notice: To ensure compliance with federal flammability requirements, the border wrap must be positioned correctly within the mattress as shown.

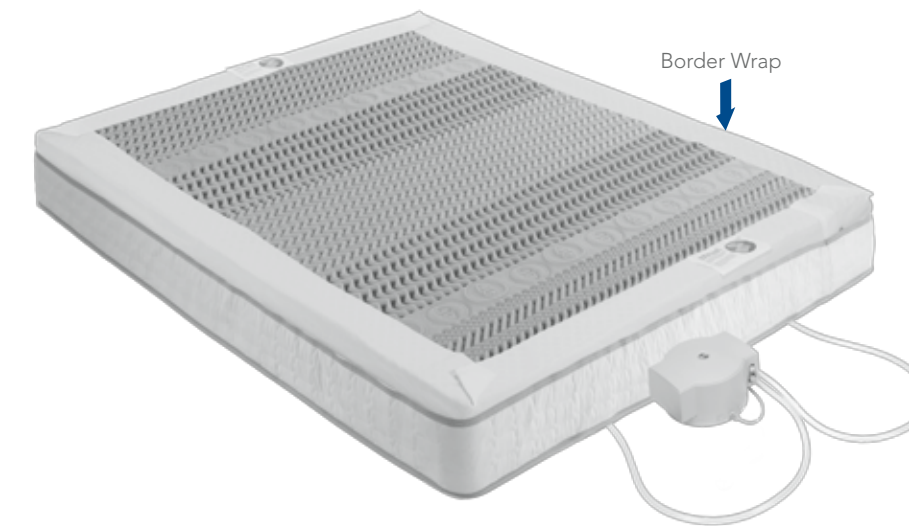
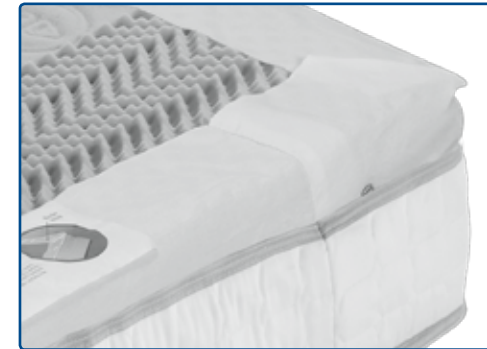

10 Mattress Cover Top

- To close mattress cover, place mattress cover top on bed and ensure zipper pull is at head of bed
- Make sure the zipper pin is completely inserted into the zipper box. Zip the top of the mattress cover closed

Poor zipper alignment

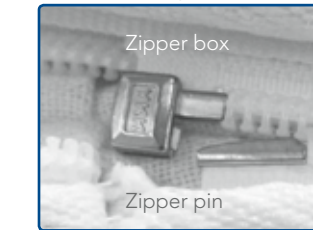

Proper zipper alignment

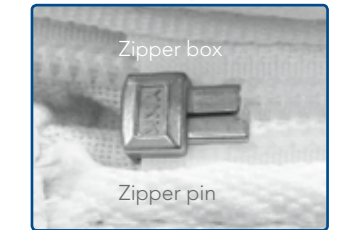

Foam color and pattern may vary.

Your Remote and Its Functions

Single Chamber
(wakes when any button is pressed)

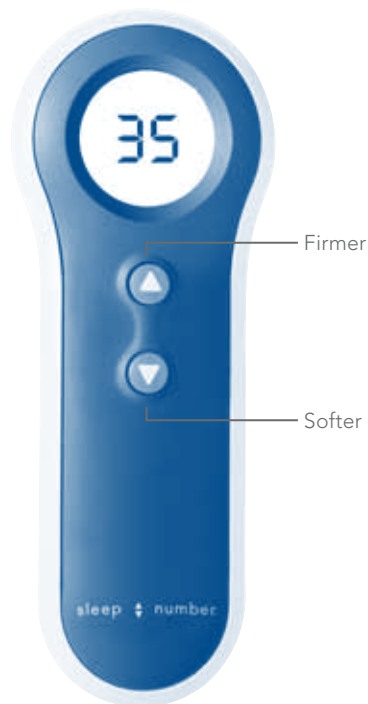

Dual Chamber
(wakes when L or R button is pressed)

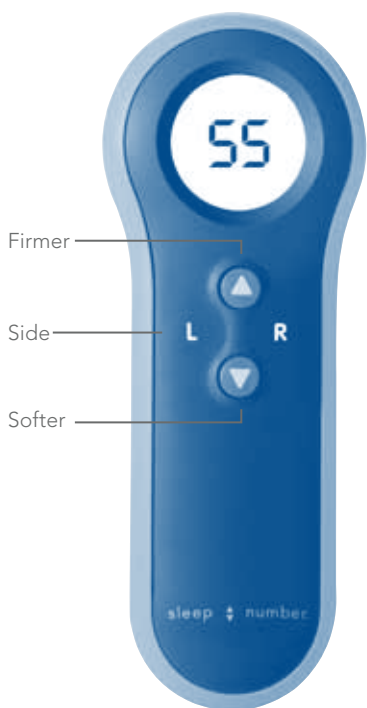

Button	Function
Side (L) and (R)	Press to choose a side; it will display the previous SLEEP NUMBER® setting.
Firmer ▲ Softer ▼	Press and hold the ▲ or ▼ button. Adjustment will begin after a slight delay. Release the ▲ or ▼ button to see the <i>Sleep Number</i> setting.

A 9-Volt battery is included and should last about six months under normal use. Replace the battery when the low battery indicator is displayed.

For more information on your remote see pages 26-27.

Sleep Number® Setting

What Is a Sleep Number® Setting?

Your SLEEP NUMBER® setting is a number between 0 and 100 that represents the ideal combination of mattress comfort, firmness and support for your body, giving you the best night's sleep possible.

Your Sleep Number® Setting

When you shopped for the SLEEP NUMBER® bed, you may have discovered your *Sleep Number* setting. You should use this as a starting point when setting the firmness of your SLEEP NUMBER® mattress. If you don't already have your *Sleep Number* setting, or if you would like to experiment with finding a different *Sleep Number* setting, use the instructions below.

Find Your Sleep Number® Setting

Step 1 — Ready - Lie down in your favorite sleeping position and adjust your pillow to your liking. Using your remote, change your *Sleep Number* setting to 100 (firmest), and then down to 20 (very soft).

Step 2 — Set - Next, set your *Sleep Number* back to 100. As the mattress gets firmer, how do your neck, shoulders, hips and back feel? When you feel comfortably supported, stop. Make adjustments up or down by 5-10.

Step 3 — Sleep - Try sleeping at this setting for 3-5 nights. If you need to make an adjustment, change your number by 5-10, and try this new setting for 3-5 nights.

Evaluating Your Comfort Level

As you are customizing the *Sleep Number* bed for your optimum comfort level, you will want to evaluate your sleep position and determine how you feel as compared to the diagrams shown to the right, then make adjustments to your firmness or pillow if needed. Your pillow should help keep your body aligned properly, otherwise it may interfere with your ability to sleep comfortably. Visit sleepnumber.com or one of our stores to get fit for a perfect pillow and see the extensive selection of innovative pillows we carry for all sleep positions and fill preferences.



- Neck and back are aligned in the same position as when you are upright
- No discomfort at shoulder and hip pressure points
- You feel the mattress support the small of your back (back sleepers) or the curve of your side (side sleepers)

- Body alignment is not straight
- Your pillow makes your head tilt at an angle to the rest of your body
- You feel discomfort from pressure at your neck, shoulders, back, hips or legs

Give It Time

It sometimes takes several nights of sleeping at different settings to discover your ideal *Sleep Number* setting. If you would like to experiment further with your *Sleep Number*, you may want to consider keeping a sleep journal. When you have found a *Sleep Number* setting where you feel comfortable, log this number into your sleep journal. Try to sleep at this *Sleep Number* setting for three to five nights, adjusting in increments of 5 or 10 only. It will take your body that long to become accustomed to a new sleep surface. After five nights, reevaluate your comfort level and log the new setting into your sleep journal, adding comments if helpful. Repeat the process until you have found the perfect setting for you.

If, after trying four different *Sleep Number* settings, you have not found your ideal *Sleep Number* setting and would like additional assistance, go to sleepnumber.com and click on Customer Service or call 1.800.790.9298 to reach a Customer Service Representative. Our trained Customer Service Representatives will provide help to improve your comfort. Your sleep is our expertise.

Things to Remember

- Reasons to alter the firmness of your bed
 - strained muscles
 - back pain
 - weight change
 - pregnancy
 - sunburn
 - new sleep position

as well as

- to facilitate getting out of bed, if needed
- to achieve a fuller bed appearance

- Dual Adjustability

If you purchased a dual chamber bed, you have the ability to personalize each side of your SLEEP NUMBER® bed. Since no two body types are the same, each sleep partner should find their own comfort level.

If your bed came with one remote for a dual chamber bed, the “L” button on the remote corresponds to the left side of the bed (left is determined when lying on your back on the bed). The “R” button corresponds to the right side.

Sleep Number® Setting Study

As you can see in the chart below, *Sleep Number* bed owners find comfort at all settings from 5–100, however the majority of sleepers find their SLEEP NUMBER® setting between 35 and 50.

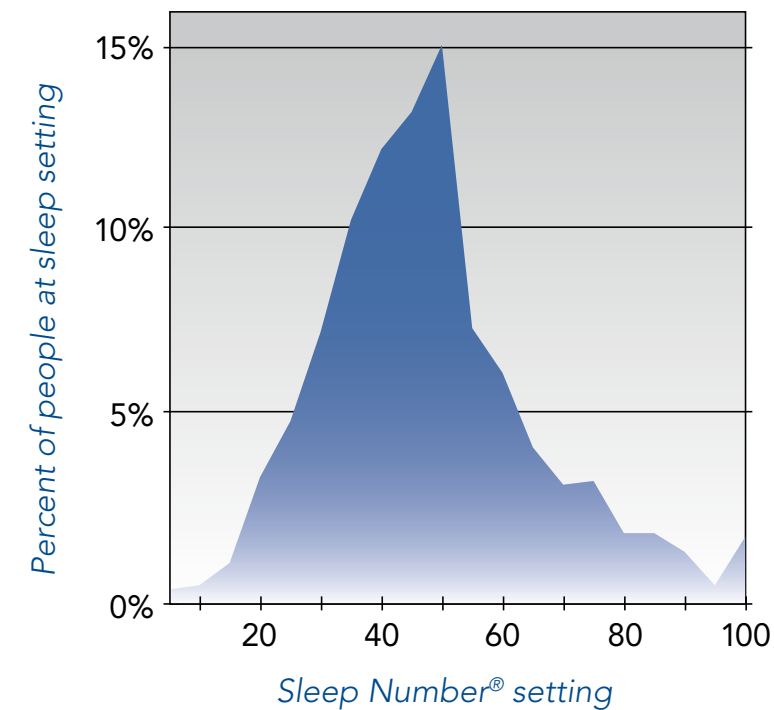

Product Care

Mattress Care

The cover of your SLEEP NUMBER® mattress may be spot cleaned with carbonated water. Do not dry clean the mattress cover or put it in a washing machine. Also, please do not apply stain guard, as it may cause yellowing of the fabric.

SLEEP NUMBER is a leader in the industry in the use of materials designed to inhibit the growth of allergens or microorganisms.

Advanced antimicrobial safeguards are incorporated into every SLEEP NUMBER® bed. Key components of the mattress have been treated to protect the bed from contaminants such as mold, mildew and bacteria growth. The unique, zip-open design of the *Sleep Number* bed allows you to easily open, ventilate or vacuum if you choose.

In rare instances under the right conditions, mold or mildew can form inside many types of mattresses, bedding or upholstered products. Should this condition occur in your mattress, please contact our Customer Service department at 1.800.790.9298 so we can work with you to return your bed to factory-fresh condition.

Remote Care

To Clean:

- Wipe body of remote with a clean cloth dampened with a mild soap and water solution
- Wipe the display screen with a clean, dry, lint-free cloth
- CAUTION: Do not immerse in water or place in dishwasher

Transporting Your Sleep Number® Bed

Your *Sleep Number* bed is lighter than any conventional bed, making it much easier to move.

Moving your bed

- Always disassemble the base. Bag all hardware so that it is not lost
- The mattress can be fully inflated, capped off and packaged in a mattress box for moving
- If you don't have a mattress box, the cover and foam should be double-bagged to prevent stains. The air chamber(s) should be deflated and boxed to prevent possible damage
- Pack the Firmness Control™ system in a box with packing material. It should be transported with minimal exposure to shock and vibration
- Tuck the remote, caps and instructions in the box with the Firmness Control™ system to prevent them from being lost

Warranty and Notification

Return Policy and 30 Day In-Home Trial

We hope you are completely satisfied with your SLEEP NUMBER® bed, but if you are not, contact QVC. They will be able to provide you with further details.

Defective or Damaged Components

If any component of the mattress or base is found to be defective in materials or workmanship within the first two years of the original purchase date, they will be replaced by *Sleep Number* at no cost to you. Within the first two years, all shipping charges to replace a defective component will be covered by *Sleep Number*. If any component of the mattress or base is found to be defective in materials or workmanship after two years from the original purchase date, the terms of the Limited Warranty will apply. After two years from the date of purchase, you will be responsible for the cost of shipping the defective component back to *Sleep Number* and any related costs. Contact our Customer Service department at 1.800.790.9298 for troubleshooting assistance and if you need to process a replacement order.

In the event that replacement components are required or if you wish to upgrade to newer components that are not covered in the warranty, you may purchase these items by simply providing proof of purchase. All component sales are final and carry a 2-Year Limited Warranty from the purchase date. Product discounts and bedding promotions do not apply to components. Call our Customer Service department for current pricing and to process a component purchase at 1.800.790.9298.

Limited Warranty

What is covered: Select Comfort ("SLEEP NUMBER") provides a limited warranty for your mattress and/or base. The limited warranty provides protection from defects in materials and workmanship for a period of 20 years from the original purchase date. Warranty is limited to product repair or replacement only.

What we will do: *Sleep Number*, at its option, will repair or replace the warranted product or component at a cost to the original purchaser based on the following table. The "price" is the price of the warranted product or component at the time the warranty claim is made, or the price of a comparable product or component if the original product or component is no longer in production.

Years after purchase date	Original purchaser's cost
Up to 2 years	No Cost
2-20 years	20% plus 4% of price for each year from original purchase date

For example, if a warranty claim arises 12 years after the original purchase date, the cost to the original purchaser would be 68% of the price (that is, 20% plus 4% for each of the 12 years) and *Sleep Number* would be responsible for the remaining 32% of the price.

Sleep Number reserves the right to substitute products or components of equal or better quality, and to use or deliver refurbished products or components in the repair or replacement of any product under this Limited Warranty.

- What is not covered:
- Conditions arising from normal wear and tear. (Conditions arising from normal wear and tear include, but are not limited to: mattress cover compression, foam compression, or discoloration of components)
 - Damage from tampering with any component or from opening the Firmness Control™ system
 - Damage from misuse or abuse of the warranted product or component
 - Damage from laundering or dry-cleaning
 - Acts of nature, such as but not limited to lightning damage

- What you must do:
- Return the warranted product or component in sanitary condition to an authorized SLEEP NUMBER® service center. *Sleep Number* will incur the cost of shipping up to two years after the original purchase date; after two years, the return shipping to *Sleep Number* will be at the customer's expense
 - Please telephone our Customer Service department at the number on the back cover to locate the nearest authorized service center and arrange for the return of the warranted product or component

- What will void this warranty:
- Tampering with any component or opening the Firmness Control™ system and its remote
 - Misuse or abuse of the warranted product or component
 - Sale, transfer or other disposal of the warranted product or component

- Limitations:
- Your exclusive remedy, IN LIEU OF ALL INCIDENTAL, SPECIAL OR CONSEQUENTIAL DAMAGES, INCLUDING FOR NEGLIGENCE, is limited to repair or replacement of any product or component deemed to be defective under the terms and conditions stated above. *Sleep Number* will bear no other damages or expenses
 - Customer maintains responsibility for installation of parts replaced under terms of the warranty
 - *Sleep Number* reserves the right to refuse to repair or replace any product or component that is returned in an unsanitary condition
 - Warranty for exterior surfaces against stains and soil is limited to manufacturer's defect only, within the first 30 days of delivery. No other warranty coverage against stains and soils is included
 - This Limited Warranty applies only to the product as used in the United States and Canada. It is not applicable in U.S. territories or other countries
 - This Limited Warranty is non-transferable
 - Repair or replacement of a product or component under the terms of this Limited Warranty in no way lengthens the Limited Warranty period
 - ANY IMPLIED WARRANTIES APPLICABLE TO THIS PRODUCT, INCLUDING ANY WARRANTIES OF MERCHANTABILITY OR FITNESS FOR A PARTICULAR PURPOSE, ARE LIMITED IN DURATION TO THE DURATION OF THIS WRITTEN LIMITED WARRANTY

Some states do not allow the exclusion or limitation of incidental or consequential damages, or limitations on how long an implied warranty lasts, so the above limitations may not apply to you. This warranty gives you specific legal rights and you may also have other rights, which vary from state to state.

All claims relating to the Limited Warranty of SLEEP NUMBER® products should be made by contacting Customer Service at the number on the back cover or writing to Sleep Number Customer Service, 9800 59th Avenue North, Minneapolis, MN 55442.

Firmness Control™ System Notification

This device complies with Part 15 of the FCC Rules. Operation is subject to the following two conditions: (1) this device may not cause harmful interference, and (2) this device must accept any interference received, including interference that may cause undesired operation. To comply with the FCC RF exposure compliance, no change to the antenna or the device is permitted. Any change to the antenna or the device could result in the device exceeding the RF exposure requirement and void user's authority to operate the device.

- Important Safety Instructions:
- Your SLEEP NUMBER® bed is intended for in-home, non-commercial use only. Any unintended use voids the limited warranty
 - The remote is not a toy and should be used under adult supervision
 - Do not open the Firmness Control™ system or remote(s) (with the exception of the battery compartment). The warranty is void if these units are tampered with
 - Keep the Firmness Control™ system and remote(s) away from heat sources such as radiators, heat registers, etc.
 - Firmness Control system and remote(s) are not water resistant. Do not use or store near water – for example, in a wet basement, near an open window, etc.

FAQ'S

Base FAQ'S

Q. What if I can't get my center support beams flush with the side rails?

A. Make sure the letter on the center support beam matches the side rail. For example, the end of the support beam labeled "A" should connect to the side rail with the "A" on it. Additional force may be required.

Q. How can I get my pins in all the way?

A. Insert pins by sliding into side rails in the direction of the arrow. Make sure that the top of the pin is flush with the top of the side rail.

Q. What can I do if I can't get the deck panels to lay flat?

A. First, make sure all the pins and beams are flush. Then, set the deck panel over the notches. You should then be able to slide the panel inward into place.

Q. Where is the hardware for the footboard and headboard brackets?

A. The same hardware for attaching the legs to the base is used for attaching the brackets.

Mattress FAQ's

Q. Where are the caps for air chamber(s)? And where should I store them?

A. The caps are in the Firmness Control™ system box. Please store these in the mattress cover in case you should ever want to disassemble your bed and temporarily cap your air chamber(s).

Q. What if my foam comfort pad appears to be too small or irregular?

A. Gently shake the pad as you place it on your mattress and it will recover its full size overnight.

Q. What if I feel like I'm rolling toward the edge or toward the center of the mattress?

A. Although rare, these sensations could potentially be experienced if one side of the mattress is set quite firm and the other side quite soft. Call Customer Service at 1.800.790.9298 for a remedy to this situation if it is bothersome to you.

Q. What if I notice a rubber smell from the air chamber(s)?

A. The odor you may smell is non-toxic and will fade over time. To minimize the smell, unzip the mattress cover and allow the air chamber(s) to air out for a few hours. Laying a couple of dryer sheets on top of the air chamber(s) will also help mask any odor by adding a fresh scent.

Q. Why are there body impressions on the mattress cover?

A. For the best looking, most crisp appearance, customers should fully inflate the mattress (100 if using a digital SLEEP NUMBER® remote). If going to full inflation does not help with body impressions in the cover, the quilted top can be removed and shaken to restore some of the loft to the fiberfill. In addition, a household vacuum nozzle may be used to fluff the cover in areas where the fibers have settled from use.

Body impressions in a normal innerspring mattress would be an indication that the spring support is compressing or breaking down. The SLEEP NUMBER® bed uses air to support your body. Since air cannot break down, you receive the same air chamber performance after years of use as you do on the first day of use.

Firmness Control™ System FAQ'S

Q. Why does my Sleep Number® setting change?

A. There are several factors that can contribute to fluctuations in a SLEEP NUMBER® setting. A *Sleep Number* setting is based on the combination of body weight, volume of air in the air chamber and sleep position.

- Temperature: An increase or decrease in temperature can cause changes in a *Sleep Number* setting. For example, a heated mattress pad will cause the *Sleep Number* setting to increase.
- Barometric Pressure: Changes in atmospheric pressure related to weather and altitude can cause your *Sleep Number* setting to change.
- Weight: The Firmness Control™ system acts similarly to a scale; more weight means a higher *Sleep Number* setting. In addition, the way that the weight is distributed will affect the reading.
- Sleep Position: The more concentrated the weight is, the greater chance the *Sleep Number* setting will be higher (i.e., when you lie on your side). When it is distributed throughout the chamber more, it is more likely that the *Sleep Number* setting will be lower (i.e., when you lie on your back or stomach).

Q. What do I do if the Firmness Control™ system doesn't run?

A. Make sure the power cord is securely plugged into the Firmness Control™ system and the wall outlet. Check to see if the power cord is plugged into an outlet that has power and is not connected to an on/off wall switch.

Q. I feel the mattress is losing air. What should I do?

A. Air loss can be caused by an unsecured hose connection, a defective air chamber, or a defective Firmness Control™ system. First, make sure the air hoses are securely connected to the air chambers. If you do not find any damaged or loose connections, then please identify which of the following situations matches your situation and follow the instructions for remedying your issue.

NOTE: To avoid variations in your SLEEP NUMBER® setting or level of comfort, make sure that you are lying in your normal sleep position when adjusting and checking your *Sleep Number* setting.

If you have a dual air chamber bed and suspect only one (1) side of your SLEEP NUMBER® bed is getting softer...

- Inspect the o-ring and connectors for cracking or damage.
- Switch the air hoses on the air chambers so the Left hose (labeled as L on the Firmness Control™ system hose) is attached to the Right air chamber and the Right hose (no labeling on the hose) is attached to the Left air chamber. You should hear a click when the air hose is securely connected to the air chamber.
- Fill the air chambers to the appropriate *Sleep Number* setting(s) for the person sleeping on each side of the bed.
- Sleep on the bed and monitor the feel of the bed's firmness on both sides.
- If neither chamber feels softer over time, you may have had a loose connection that was fixed during the switching of hoses. Switch the hoses back to their correct positions and continue to use the bed as normal.
- If an air chamber feels softer after switching air hoses, please contact Customer Service with the results (the issue stayed on the same side of the bed or it moved to the other side after switching hoses).

If you have a dual air chamber bed and both (2) air chambers are getting softer or have a single air chamber bed and feel the air chamber getting softer...

- Inspect the o-ring and connectors for cracking or damage then reconnect the Firmness Control™ system to the air chamber(s).
- Lie down in your normal sleep position and fill the air chamber(s) with suspected air loss to your normal *Sleep Number* setting plus an additional 15 points (i.e., if you sleep at 35, fill to 50). We ask that you over-inflate to compensate for air that may escape in one of the next steps.
- Locate the air chamber caps that came with your bed.*
- Remove the hose from the air chamber and quickly cap the chamber.
- Leave the air chamber(s) capped for a minimum of 48 hours.
- If the air chamber(s) become noticeably softer when capped, contact Customer Service.
- If the air chamber(s) hold air, reconnect the pump and continue using the bed. The air loss issue may have been due to environmental factors or a connection issue. Contact Customer Service if the air loss issue returns after reattaching the Firmness Control™ system.

*Caps are typically found at the head of the bed inside the mattress cover in a small plastic bag. If you cannot find the caps, they may be available at your nearest SLEEP NUMBER® store or can be requested by emailing Sleep Number at CustomerService@selectcomfort.com with your request, or by calling 1.800.790.9298.

Q. Will my bed deflate if there is a power surge or power loss?

A. No, your mattress will maintain its firmness. To protect your Firmness Control™ system, we recommend using a surge protector.

NOTE: The warranty does not cover damage to the Firmness Control™ system due to a power surge. Using a surge protection device (not included) is recommended.

Q. The wireless pump remote is displaying "Er." What is the problem?

A. An "Er" indicates there is an error. The Firmness Control™ system base may not have power, or the remote and Firmness Control™ system base may have lost communication with one another.

- Make sure the Firmness Control™ system is firmly plugged into a working outlet and is receiving power. Check to make sure the outlet is not controlled by a wall switch. You will know that the unit has power if it "clicks" when you plug it in.
- Make sure that the power cord is plugged into the side of the Firmness Control™ system.
- Wait for the display to shut off (about 10 seconds). Then try to adjust the bed again.
- If the "Er" persists call Customer Service at 1.800.790.9298

Q. Why does my Sleep Number® deflate past what I am trying to set it to?

A. Your Firmness Control™ system has software that it uses to inflate and deflate efficiently. If it is not deflating correctly, the pump may have lost power or did not train properly when it deflated the first few times it was operated. See page 17 to calibrate. This procedure should be performed any time the pump has lost power.

Help is just a click or phone call away

If you ever have product questions or need additional assistance obtaining optimal comfort, please visit us at:

mygoldservice.com

or call

1.800.790.9298

Representatives are available
(Central Standard Time):

Monday–Friday 8 a.m. – 6 p.m.

Saturday 8:30 a.m. – 5 p.m.

Sunday Closed

sleep  number.

9800 59TH AVENUE NORTH
MINNEAPOLIS, MN 55442



117780

9/11

