



55

20



sleep  number®

FlexFit™

ADJUSTABLE BASE FLEX FIT  
ASSEMBLY INSTRUCTIONS

## Congratulations on Your Purchase of the FlexFit™ Adjustable Base

You're about to take the personalized comfort of your Sleep Number bed to the ultimate level. By adding the FlexFit™ adjustable base, you're creating an even more personalized sleep environment, and enhancing the customized comfort of the bed that can significantly improve your sleep quality.

As a SLEEP NUMBER® bed owner, you're a member of our InnerCircle<sup>SM</sup>. You're one of the nearly 7 million well-rested Insiders who are lifetime members of our Sleep Number® family. If you haven't already registered your bed, now's a great time to do so by visiting [sleepnumber.com/innercircle](http://sleepnumber.com/innercircle). As an Insider, you'll receive exclusive benefits including the latest news from Sleep Number, Insiders-only discounts, and great referral rewards\*. Plus, you'll always get 10% off every purchase from our exclusive SLEEP NUMBER® Bedding Collection and additional Sleep Number beds.

At Sleep Number, we're dedicated to improving your sleep with new and innovative products; everything from beds to bedding solutions designed to help you sleep just right. We know that you, too, will fall in love with Sleep Number® comfort, quality, and customer service—and a truly individualized sleep experience.

Here's to a great night's sleep!



William R. McLaughlin  
President & CEO

My Sleep Number® is 55

\* See Owners' InnerCircle<sup>SM</sup> Rewards Section for details. SLEEP NUMBER, SELECT COMFORT and the Double Arrow Design are registered trademarks of Select Comfort Corporation.



## What's Inside

Congratulations! Your new Sleep Number FlexFit™ Adjustable Base is set up and ready to enjoy. Inside, you'll find instructions for the easy-to-use hand control. Whether reading, relaxing or sleeping soundly, we know you'll fall in love with comfort you can adjust in every way. Look to Sleep Number for innovations with your individual needs in mind.





- ▶ Base Assembly ..... pg 4
- ▶ Mattress Assembly ..... pg 6
- ▶ Hand Control Function ..... pg 7
- ▶ Headboard Bracket Assembly ..... pg 8
- ▶ Accessories ..... pg 11
- ▶ Troubleshooting ..... pg 12
- ▶ Warranty ..... pg 15



**“** We are so grateful every night we go to bed. We just adjust the head, foot and the firmness according to how we feel on that day and we are set to have a good night. **”**

- Braulia V., Kennewick, WA

## BASE ASSEMBLY

	QUANTITY	
	Full/Queen	King
<p><b>Hand Control</b></p> 	1	1 2 for Split King
<i>HARDWARE BOX</i>		
<p><b>4-inch Leg</b></p> 	4	8
<p><b>Caster</b></p> 	4	8
<p><b>Headboard Bracket Assemblies</b></p> 	1	1 2 for Split King
<p><b>Headboard Bracket Hardware Kit</b></p> 	2	2 4 for Split King
<p><b>Retainer and Adhesive Kit</b></p>	1	2 2 for Split King

# MATRESS ASSEMBLY

## 1 INSTALL MATRESS

Tools required—utility knife, Phillips® head screwdriver.

Verify FlexFit™ adjustable base setup is complete. Identify and remove (2) locator pins in the adjustable base. Note: approximate locator pin position is 32-1/2" from the top and 6" from the side of the adjustable base. Locator pins mark threaded lug location used for SLEEP NUMBER® mattress attachment. Unzip the top panel of the Sleep Number mattress cover and set the panel aside. Position the bottom of the Sleep Number mattress on top of the adjustable base.

**IMPORTANT:** Wash hands before beginning installation. Residue on hands will easily transfer to cloth-covered bed components.

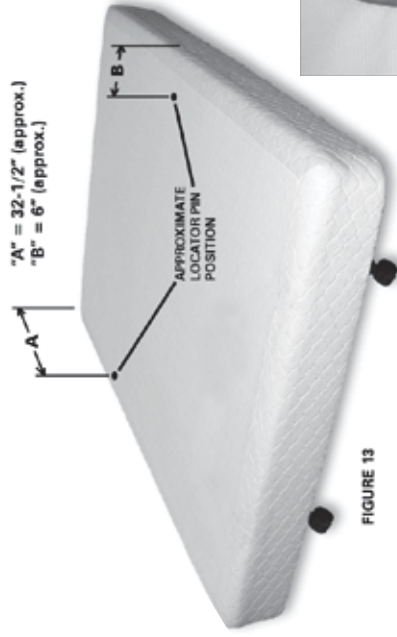
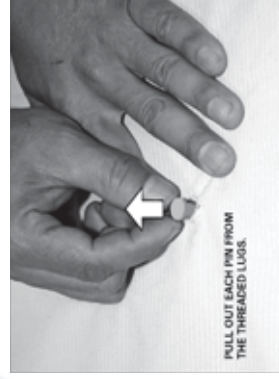

FIGURE 13



## 2 ALIGN MATRESS

Insert foam border walls and corner locks into the mattress cover per the Sleep Number mattress installation instructions. Align the top and side edges of the mattress cover flush with the adjustable base so the mattress cover and the base are a matched pair. Locate the (2) threaded lug mounting locations (with fingers).

**NOTE:** Exact side and end alignment of the Sleep Number mattress cover assembly with the adjustable base must be achieved before proceeding to the next step.

### 3 INSTALL MATTRESS RETAINER KIT

At each threaded lug location, make a small cut (no larger than 1/4" long) through the mattress cover fabric with a utility knife. Position an adhesive pad over each cut in the mattress fabric cover. Position a large plastic washer over the adhesive pad. Position a metal washer over each plastic washer. Insert one of the mounting bolts through both washers and screw into one of the mounting lugs. Snug fit...Do not overtighten! Complete mattress setup per the SLEEP NUMBER® installation instructions. This will include fitting the base pad, air chambers, center wall and topper pad.

Position and zip the top panel to the SLEEP NUMBER® mattress cover to complete installation.

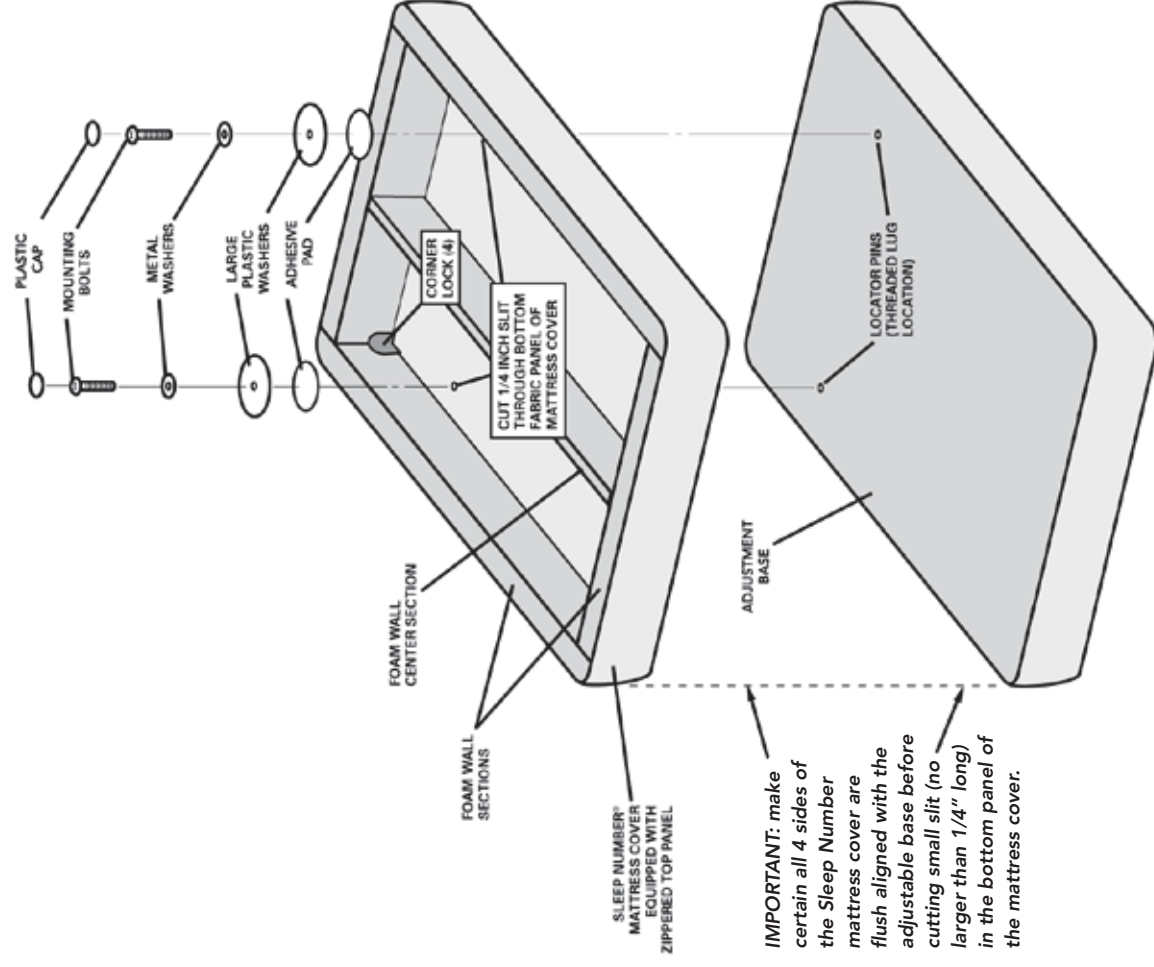

**WARNING:** Exercise extreme caution when using utility knife. The danger of serious finger cuts are possible if utility knife is not used correctly.

**NOTE:** Sleep Number mattress hardware and components vary per model. If adjustable base service is required, remove the Sleep Number mattress before the service technician arrives.

# HAND CONTROL FUNCTION

## FLEXFIT™ ADJUSTABLE BASE

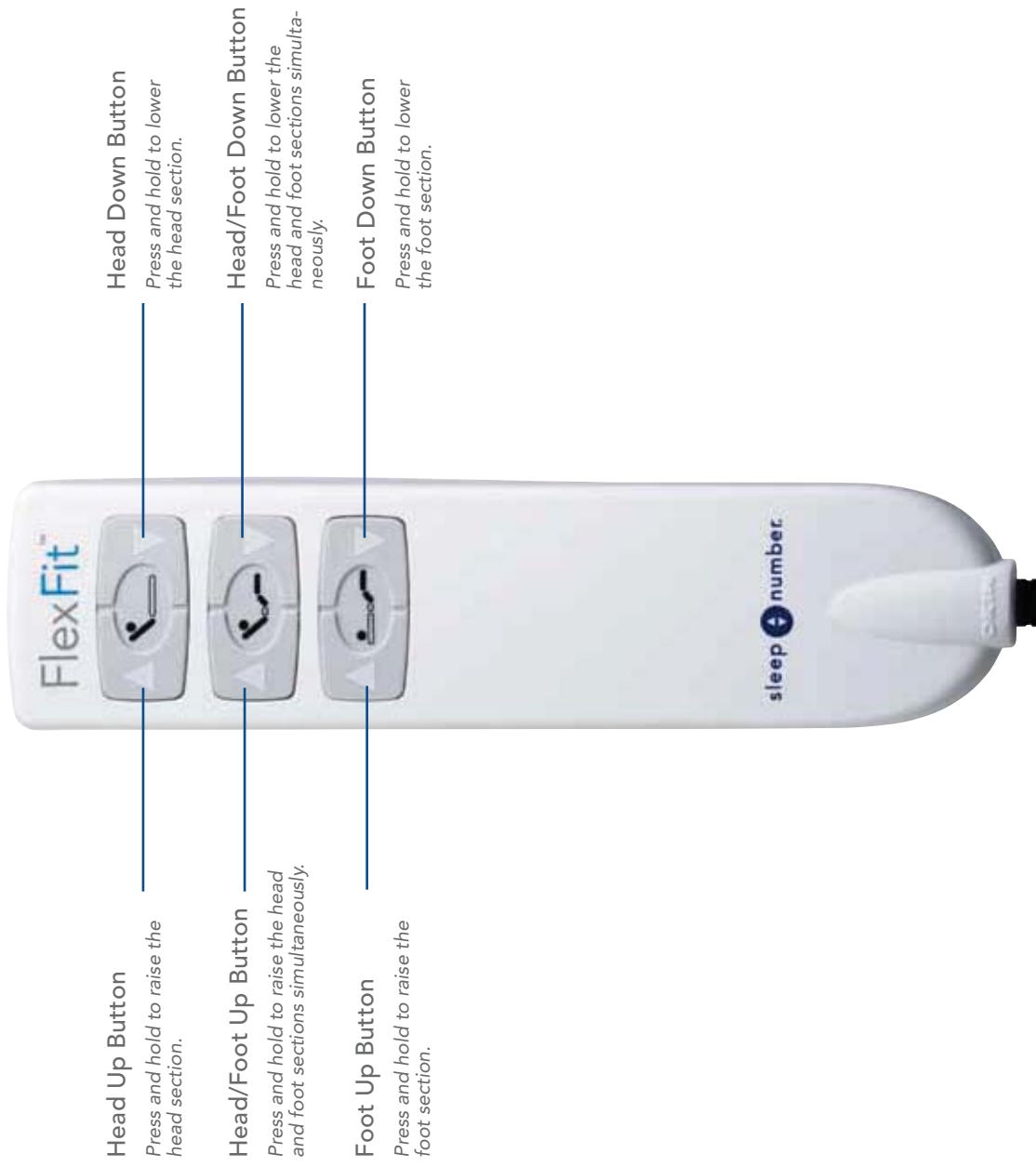

# HEADBOARD BRACKET ASSEMBLY OPTIONAL

## 1 INSTALL OPTIONAL HEADBOARD BRACKETS

Headboard brackets are only needed for non-free standing headboards.

Raise the head section of the bed (with hand control) to gain access to the bed base frame.

Locate channel connector kit. On (1) side of the bed base frame, locate (2) holes for channel connector mounting.

(2) Channel connector mounting holes

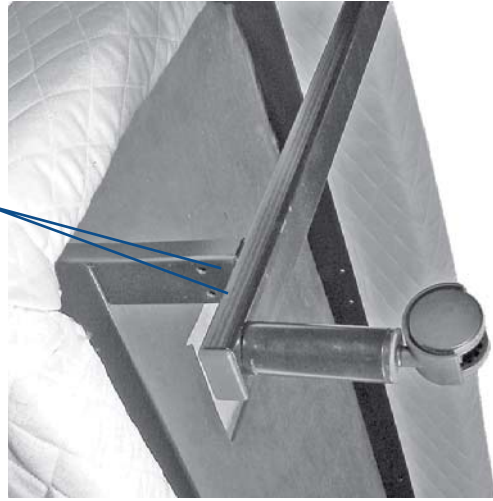

## 2 POSITION CHANNEL CONNECTOR

For beds with full base length, use inner mounting holes. For beds with Queen, King or Cal King base length, use outer mounting holes.

Position channel connector so the flat side is flush against bed base frame. Attach channel connector to bed base frame using (2) 1½-inch long hex head bolts/nuts.

(2) 1½" Long Hex Head Bolts and Nuts

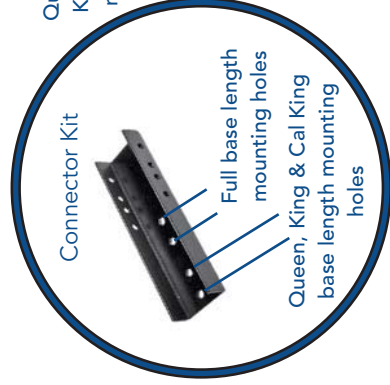
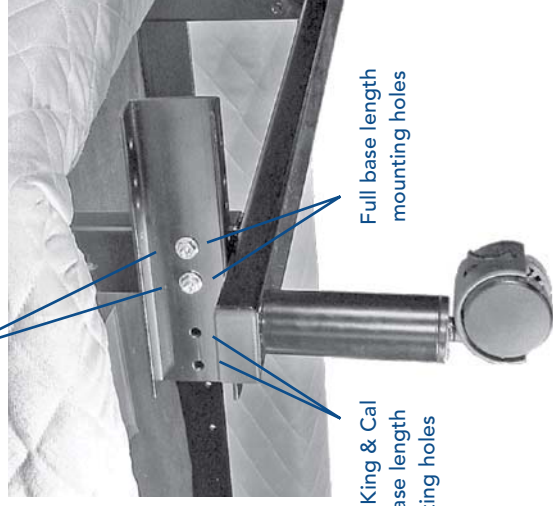

Cover color and pattern may vary.



### 3 ATTACH HEADBOARD BRACKET

Using (2) 3-inch long carriage bolts/nuts, attach (1) headboard bracket channel to (1) channel connector. Hand tighten bolts/nuts (loosely) to allow adjustment of the headboard bracket channels.

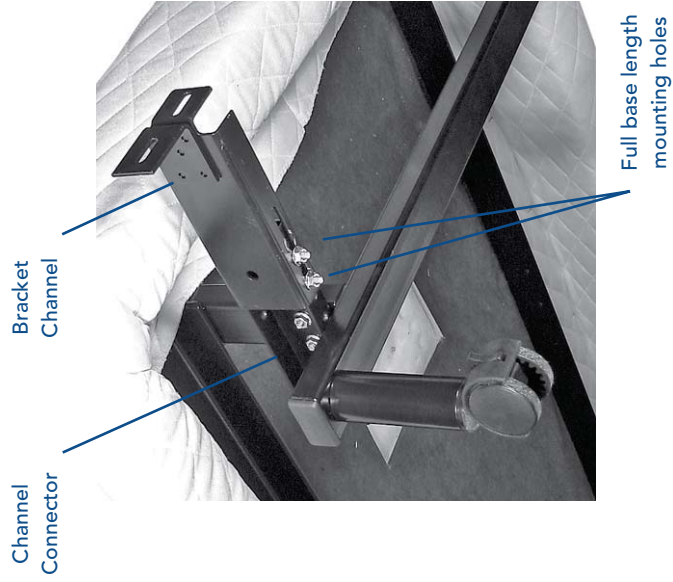

### 4 ATTACH HEADBOARD BRACKET FLANGE

Attach (1) headboard bracket flange to one of the bracket channels with (2) 1-inch long hex head bolts/nuts.

Repeat procedure to attach the other headboard bracket.

Slide headboard bracket assemblies (in or out) to achieve a distance of 1½ inches (38.1 mm) to 2 inches (50.8 mm) between the edge of the bed base and headboard bracket flange assemblies.

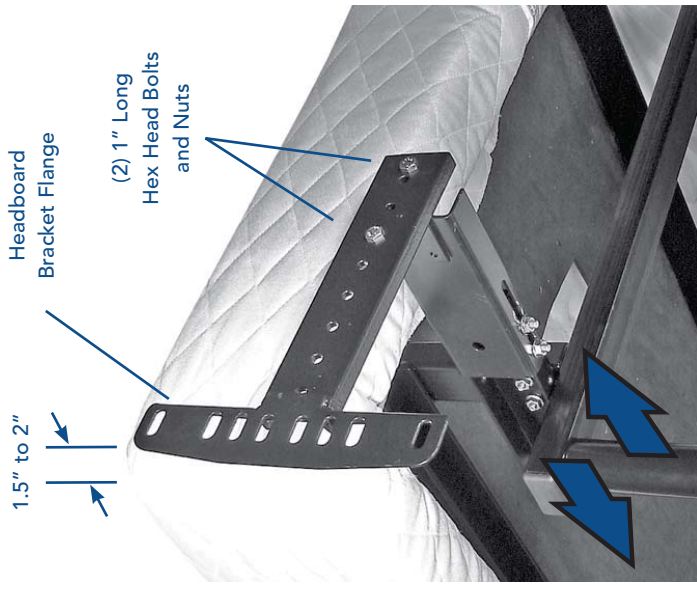

## HEADBOARD BRACKET ASSEMBLY OPTIONAL

### 5 ADJUST AND SECURE

Firmly tighten the 3-inch long carriage bolts of both headboard bracket channels.

Measure the distance (center-to-center) between the mounting holes in the headboard.

Measure the center-to-center distance between the mounting slots of the headboard bracket flanges.

If bracket flange adjustment is required to accept the headboard, remove the 1-inch long hex head bolts and move flanges side-to-side for the adjustment. Reinstall bolts. Tighten all headboard mounting bolts.

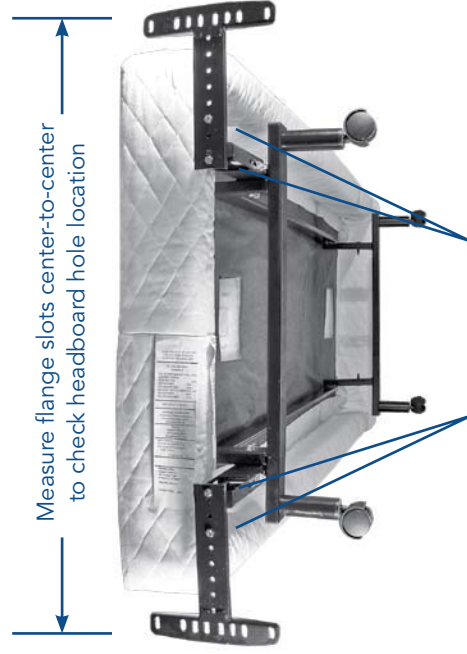

Remove 1-inch long hex head bolts and relocate flanges to achieve center-to-center distance required for headboard mounting holes

### 6 INSTALL HEADBOARD

Securely install your headboard.

#### **IMPORTANT SAFETY NOTICE:**

The bottom of the headboard cross member must be positioned so that there is no more than 3 inches (76.2mm) between the headboard and the top of the mattress.

Do not exceed 3 inches (76.2mm) in order to avoid a person or pet being caught in the space (referenced in adjacent figure) while the bed is in motion.

Failure to follow this instruction could result in serious personal injury or death.

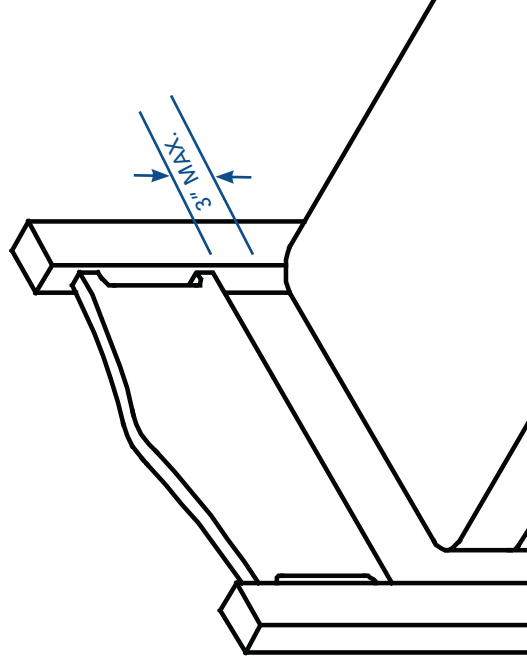





Headboard cross member location must not exceed 3 inches (76.2mm) from the top of the mattress.

# ACCESSORIES

## FlexFit™ OPTIONAL EQUIPMENT

Call toll free at 800-580-7216 for accessory pricing and to order the accessories indicated in the chart below:

Accessory Description	Code	
<b>Glides</b> set of 4, replaces legs (headboard bracket cannot be used with glides)	107397	
<b>7" Legs</b> set of 4	107399	
<b>Swing Away Hinges</b>	107396	
<b>Bed Straps</b> connects 2 FlexFit bases together	107398	

# TROUBLESHOOTING

In the event the FlexFit™ adjustable base fails to operate, investigate the symptoms and possible solutions provided in the chart below:

Symptom	Solution
No features of the adjustable bed will activate.	<ul style="list-style-type: none"> <li>Verify power cord is plugged into a working, grounded electrical outlet. A grounded, electrical surge protection device is recommended. Test outlet by plugging in another working appliance.</li> <li>Unplug power cord, wait 30 seconds and plug in to reset electronic components.</li> <li>Electrical circuit breaker may be tripped. Check electrical service breaker box to verify.</li> <li>Surge protection device may be defective. Replace surge protection device.</li> </ul>
Head or foot section will elevate, but will not return to the horizontal (flat) position.	<ul style="list-style-type: none"> <li>Bed mechanism may be obstructed. Elevate bed and check for obstruction. Remove obstruction.</li> <li>Head section may be too close to the wall.</li> </ul>

Symptom	Solution
<p>Foot end of bed base unlevel.</p>	<ul style="list-style-type: none"> <li>On one side of bed base, loosen jam nut on board end of turnbuckle assembly using a 1/2" wrench. Threads are right-hand threads. Repeat on other side of bed base.</li> <li>Loosen jam nut on carriage end of turnbuckle assembly with wrench. Threads are left-hand threads.</li> <li>Repeat on other side of bed base.</li> <li>After loosening both jam nuts, grasp and rotate the body of the turnbuckle on one side of the bed base. The foot of the bed base will rise and flatten out.</li> <li>Repeat on other side until bed base is completely level.</li> <li>After adjustments have been made, check the levelness of the bed base using a straight-edge instrument. When level, tighten all jam nuts in assembly with 1/2" wrench. Hold the body of the turnbuckle assembly while tightening to ensure base remains level. Jam nuts need to be tight enough to prevent movement in turnbuckle.</li> </ul>

# ADVISORY

## IMPORTANT INFORMATION

### ► Read the following information carefully before using this product

This FlexFit™ adjustable base has been quality engineered with design features to assure comfort and safety when operated properly.

## PRODUCT RATINGS

The bed lift motors are not designed for continuous use. Reliable operation and full life expectancy will be realized as long as the lift motors do not operate any more than 5 minutes over a 30 minute period, or approximately 15% duty cycle. Note: massage equipped beds are not designed for continuous, extended massage operation. Massage systems are rated for a maximum of 2 hours of use within any 6 hour period. Any attempt to circumvent or exceed product ratings will shorten the life expectancy of the product and may void the warranty. The recommended weight restrictions for SLEEP NUMBER® adjustable bases are as follows: DC equipped - 450 lb (204 kg) all sizes. The bed will structurally support the recommended weights distributed evenly across the head and foot sections. This product is not designed to support or lift this amount in the head or foot sections alone. Note: exceeding the recommended weight restrictions could damage the adjustable bed and void the warranty. For best performance, consumers should enter and exit the adjustable bed with the bed in the flat (horizontal) position. **DO NOT SIT ON THE HEAD OR FOOT SECTIONS WHILE IN THE RAISED POSITION.**

## OPERATING INFORMATION

- After bed assembly is completed, operate hand control to ensure proper bed functions.
- Keep moving parts free of obstruction during bed operation (including sheets, clothing, tubing, wiring, and products using electric power cords).
- Distribute body weight evenly over bed surface. Do not place entire weight on raised or foot sections of the bed, including during repositioning and entering or exiting bed.

## ELECTRICAL GROUNDING

To reduce the risk of shock, this product has a polarized plug (one blade is wider than the other). This plug will fit in a polarized outlet only one way. If the plug does not fit fully into the outlet, reverse the plug. If it still does not fit, contact a qualified electrician to install proper outlet. Do not change the plug in any way.

This product must be grounded. In the event of an electrical short circuit, grounding reduces the risk of electrical shock by providing an escape wire for the electrical current. This product is equipped with a cord having a grounding wire or grounding plug. The plug must be plugged into an outlet that is properly installed and grounded. Do not bypass the grounding plug.

**WARNING:** improper use of grounding plug can result in risk of an electrical shock. Check with a qualified electrician or service representative if the grounding instructions are not completely understood, or if doubt exists as to whether the product is properly grounded.

**IMPORTANT SAFETY NOTICE:** For optimum adjustable base operation, use a grounded, electrical surge protection device (not included). Failure to use a surge protection device could compromise safety or cause product malfunction.

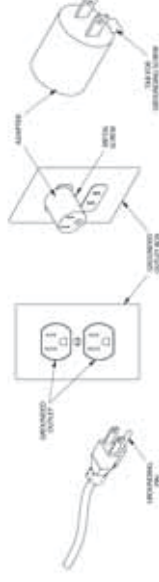

# ADVISORY

## FCC COMPLIANCE

Electrical components are rated for 110/120 voltage, 60Hz, 3.9 amp. Components meet Class B digital device rating (Part 15, FCC rules) for residential use.

## SMALL CHILDREN / PETS WARNING

After the bed is unboxed, immediately dispose of packaging material as it can smother small children and pets. To avoid injury, children or pets should not be allowed to play under or on the bed. Children should not operate this bed without adult supervision.

## HOSPITAL USE DISCLAIMER

This base is designed for in-home use only. It is not approved for hospital use and does not comply with hospital standards. Do not use this base with tent type oxygen therapy equipment, or use near explosive gases.

## PACEMAKER WARNING

If the massage feature is in use, this product produces a vibrating sensation. It is possible that individuals with heartassist pacemakers may experience a sensation similar to exercise. Consult physician for complete information.

## LIFTING/LOWERING MECHANISMS

The lift/lower feature will emit a minimal humming sound during operation. This is normal. During operation, the lift arm wheels make contact with the platform support of the bed. This applies slight tension on the moving components and resonance is reduced to a minimum level. If excessive noise or vibration is experienced, reverse the movement action (up or down) of the base with the hand control. This should realign the base's activating mechanisms to the proper operational position.

## SERVICE REQUIREMENTS

Service technicians are not responsible for moving furniture, removing headboards and footboards or any items required to perform maintenance on the adjustable bed. In the event the technician is unable to perform service due to lack of accessibility, the service call will be billed to the purchaser and the service will have to be rescheduled.

## LUBRICATION

This product is designed to be maintenance free. The lift motors are permanently lubricated and sealed—no additional lubrication is required. Do not apply lubricant to lift motor lead screws or any nylon nuts or the bed may inadvertently creep downward from the elevated position.

## LOCKING CASTER SAFETY FEATURE

This product is equipped with locking casters to prohibit the bed from movement. For best results, place rubber caster cups under locking casters when the bed is located on smooth or hard surface flooring—it is possible for locking caster equipped beds to slide without the use of rubber caster cups. To activate locking casters, push down on the lock tab. To disengage the locking mechanism, push up on the lock tab (see illustration below).



## LIMITED WARRANTY

Subject to the terms and conditions and for the periods set forth herein, Leggett & Platt, Incorporated ("L&P") warrants to the original consumer purchaser (the "Purchaser") that this adjustable bed is free of defects in material or workmanship caused by the manufacturer. This warranty begins on the "warranty commencement date" which is the earlier of (i) the date of purchase, or (ii) August 1, 2012.

**FLOOR DISPLAY DISCLAIMER: PRIOR TO PURCHASE, THIS ADJUSTABLE BED WAS A FLOOR DISPLAY MODEL USED IN SELECT COMFORT'S RETAIL STORE AND THEREFORE MAY HAVE SUFFERED COSMETIC DAMAGE WHILE ON DISPLAY, SUCH AS, BUT WITHOUT LIMITATION, SPILLS, STAINS, AND/OR OTHER MINOR EXTERIOR ABRASIONS. THIS WARRANTY EXCLUDES ALL COSMETIC ISSUES, INCLUDING, BUT NOT LIMITED TO, THE ABOVE.**

### 2 YEAR WARRANTY

Upon proper notice received during the first two (2) years after the warranty commencement date, L&P will repair or replace (at no cost to the Purchaser) any adjustable bed part found by L&P to have a defect covered by this warranty, and L&P will pay all labor and transportation costs authorized by L&P for repair or replacement of such part.

### 3 YEAR LIMITED WARRANTY

Upon proper notice received during the third year from the warranty commencement date, L&P will replace any adjustable bed part found by L&P to have a defect covered by this warranty. This limited three (3) year warranty shall not apply unless the defective part is returned to L&P within ten (10) days of Purchaser's receipt of the replacement part. Purchaser shall pay all service and transportation costs related to the replacement of the defective part.

### 15 YEAR LIMITED WARRANTY

Upon proper notice received during the fourth year through the fifteenth year from the warranty commencement date, L&P will replace, upon terms and conditions set forth in this paragraph, any non-motorized and non-electrical mechanical part found by L&P to have a defect covered by this warranty. **Electronics, electrical components, drive motors and massage motors are excluded.** This limited fifteen (15) year warranty shall not apply unless the defective part is returned to L&P within ten (10) days of Purchaser's receipt of the replacement part. In years 4 - 15, Purchaser shall pay all service and transportation costs related to the replacement of the defective part.

### ADDITIONAL TERMS AND CONDITIONS FOR ALL WARRANTY PERIODS

This warranty does not apply: (a) to any damage caused by the Purchaser or any person other than the manufacturer of the adjustable bed; (b) if there has been any repair or replacement of adjustable bed parts by an unauthorized person; (c) if the adjustable bed has been mishandled (whether in transit or by other means), subjected to physical, electrical, or other abuse or misuse, or otherwise operated, used, or maintained in any manner inconsistent with the operation and maintenance procedures outlined in this warranty or in any manufacturer instructions; (d) to damage to mattresses, fabric, cables, electrical cords or items supplied by dealers or persons other than the manufacturer (Purchaser may contact the dealer for warranty information on these items); (e) if there has been any modification of the adjustable bed **without prior written consent by L&P**; (f) to costs for unnecessary service calls, including costs for in-home service calls solely for the purpose of educating the consumer about the adjustable bed or finding an

unsatisfactory power connection; (g) if the recommended weight restriction is not followed (refer to advisory section), in which event the warranty will be void.

Repairs to (or replacement of) an adjustable bed or its components under the terms of this limited warranty will apply to the original warranty period and will not serve to extend such period. The decision to repair or to replace defective parts under this warranty shall be made, or caused to be made, by L&P at its option and in its sole discretion.

**TO THE EXTENT ALLOWED BY APPLICABLE LAW: (i) NEITHER THIS WARRANTY NOR THE WARRANTIES, IF ANY, IMPLIED BY LAW, SHALL EXTEND TO ANY PERSON OTHER THAN THE Purchaser; (ii) REPAIR OR REPLACEMENT AS PROVIDED IN THIS WARRANTY SHALL BE THE SOLE REMEDY OF THE Purchaser; AND (iii) L&P DISCLAIMS, EXCLUDES, AND IN NO EVENT SHALL HAVE ANY LIABILITY FOR, ANY SPECIAL, INDIRECT, INCIDENTAL, OR CONSEQUENTIAL DAMAGES OR ANY OTHER DAMAGE, CLAIM, OR LOSS NOT EXPRESSLY COVERED BY THE TERMS OF THIS WARRANTY. Some states do not allow the exclusion or limitation of incidental or consequential damages, so the above limitation or exclusion may not apply to every purchaser.**

This limited warranty does not include reimbursement for inconvenience, removal, installation, setup time, loss of use, shipping, or any other costs or expenses. L&P or its service technicians shall not be responsible for moving furniture or any other items not attached to the adjustable bed in order to perform service on the adjustable bed.

It is the sole responsibility of the Purchaser to provide adequate space and accessibility to the adjustable bed. In the event that the technician is unable to perform service due to lack of accessibility, the service call will be billed to the Purchaser and the service will have to be rescheduled.

**L&P makes no other warranty whatever, express or implied, and all implied warranties, including any warranties of merchantability or fitness for a particular purpose, are disclaimed by L&P and excluded from this agreement to the extent permitted by applicable law. Implied warranties, if any, which under applicable law cannot be disclaimed or excluded, are hereby limited to the same warranty periods as the express warranty herein, and are subject to the same terms, conditions, and limited remedies stated in this warranty.**

This warranty gives the Purchaser specific legal rights, and the Purchaser may also have other rights, which may vary from state to state. This warranty is valid in the United States, Puerto Rico, and Canada. Notices and claims under this warranty must be in writing and submitted to:

Select Comfort  
Customer Service Department  
6105 Trenton Lane North  
Minneapolis, MN 55442  
800-580-7216



sleep  number.

## Help is just a click or phone call away

If you ever have product questions or need additional assistance obtaining optimal comfort, please visit us at:

[sleepnumber.com](http://sleepnumber.com)

or call

**1.800.472.7185**

Sleep Professionals are available  
(Central Standard Time):

Monday–Friday	8am – 6pm
Saturday	8:30am – 5pm
Sunday	Closed

9800 59TH AVENUE NORTH, MINNEAPOLIS, MN 55442

connect with us on Facebook and Twitter



Facebook.com/SleepNumber    Beds.com/Twitter



116210

7/11

