

sleep  number®

CLASSIC SERIES BED ASSEMBLY GUIDE





Welcome to Sleep Number® InnerCircleSM

Congratulations on your purchase of the SLEEP NUMBER® bed. As a *Sleep Number* bed owner, you're now a member of our InnerCircleSM. You've joined the over 7 million well-rested Insiders who are lifetime members of our Sleep Number® family.

As an Insider, you'll receive exclusive benefits including the latest news from SLEEP NUMBER, Insiders-only discounts, and great referral rewards*. Plus, you'll always get 10% off every purchase from our exclusive SLEEP NUMBER® Bedding Collection and additional *Sleep Number* beds.

At *Sleep Number*, we're dedicated to improving your sleep with new and innovative products; everything from beds to bedding solutions designed to help you sleep just right. We know that you, too, will fall in love with Sleep Number® comfort, quality, and customer service—and a truly individualized sleep experience.

Here's to a great night's sleep!

William R. McLaughlin

President & CEO

My Sleep Number® setting is 55

* See Owners' InnerCircleSM Rewards Section for details. SLEEP NUMBER, SELECT COMFORT and the Double Arrow Design are registered trademarks of Select Comfort Corporation.

What's Inside

Setting up your new SLEEP NUMBER® bed only takes about an hour, but you'll enjoy the benefits of better sleep for years to come. You won't need any tools and, although it's nice to have a helper, you can do it by yourself. First, you'll need to remove your old bed. Next, assemble the base, position the mattress and attach the Firmness Control™ system. The *Sleep Number* bed's revolutionary DualAir™ technology lets you adjust each side to your ideal firmness[†], making it the perfect bed for couples.

- ▶ Base Assembly pg 4
- ▶ Mattress Assembly pg 10
- ▶ Firmness Control™ System pg 18
- ▶ Mattress Care pg 21
- ▶ Bedding Solutions pg 22
- ▶ Warranty and Notification to Insider pg 24
- ▶ Frequently Asked Questions pg 26

[†] Only beds with two air chambers.



"I assembled the Sleep Number bed by myself. My wife was in doubt at first, but, after sleeping one night, she said it was magic how well she slept without back pain. Now we sleep longer and more comfortably than with any previous mattress we've owned."

- C. Clark S., Tucson, AZ



BEFORE YOU BEGIN

- ▶ **Decide where to put your new bed**
- ▶ **Make sure there's an electric power source nearby for use with your Firmness Control™ system**

BEFORE YOU BEGIN YOUR BASE ASSEMBLY

- ▶ **Carefully check the contents of your base boxes**

Familiarize yourself with all of the parts by comparing them with the descriptions on the following page.

- ▶ **Prepare your bed frame, if you have one**

Your base can be assembled directly onto your current bed frame or on the floor. Some bed frames have slats that run from one side of the bed to the other. If your bed frame has slats, position the slats evenly to support the base. If your bed frame has fewer than three slats, we recommend adding additional slats to ensure adequate support for your base.

Caution: With some styles of bed frames, the base length may extend beyond the frame's support legs. This situation makes it possible for the frame to tip when significant weight is placed at the foot of the bed. Please use caution when sitting or placing weight on the foot of the bed when using these types of frames.

- ▶ **King bases**



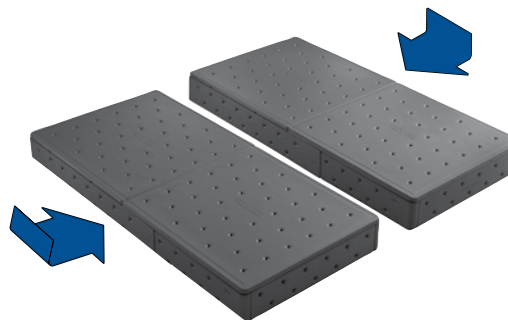

King and California King bases consist of two Twin Long bases side by side, as shown below. Complete the assembly of one unit, assemble the second, then place side by side on the bed frame.

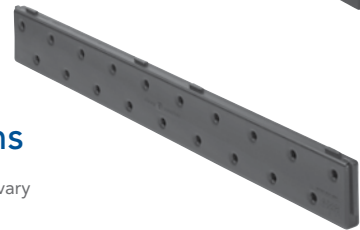
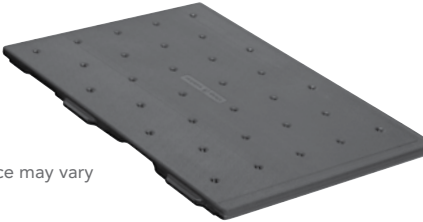

If you are missing any items listed on the following page, please call 1.800.472.7185 or e-mail Customer Service at customerservice@selectcomfort.com.

Note: Texture and surface appearance may vary.

BASE PARTS AND COMPONENTS

	Twin/ Twin Long	Full/ Double	Queen/ Expanded Queen	King/ California King
 <p>Side Rails Texture and surface appearance may vary</p>	2 each	2 each	2 each	4 each
 <p>Support/End Beams Texture and surface appearance may vary</p>	6 All labeled "End Beam"	6 2 labeled "End Beam" 4 labeled "Support Beam"	6 All labeled "End Beam"	12 King: all labeled "End Beam" California King: 4 labeled "End Beam" 8 labeled "Support Beam"
 <p>Deck Panels Texture and surface appearance may vary</p>	2	4	4	4
 <p>Pin Components</p>	2	2	2	4
 <p>Fabric Coverlet Packaged in the mattress box Shown as packaged</p>	1	1	1	1
<p><i>*Expanded Queen only</i></p>  <p>Corner Brackets Packaged in the mattress box</p>	0	0	4	0

BASE ASSEMBLY



BASE ASSEMBLY

1 SIDE RAILS

- Connect the components labeled A side rail and B side rail together.
- Make sure a shorter side rail is paired with a longer side rail for each connection; push firmly; joints fit tightly

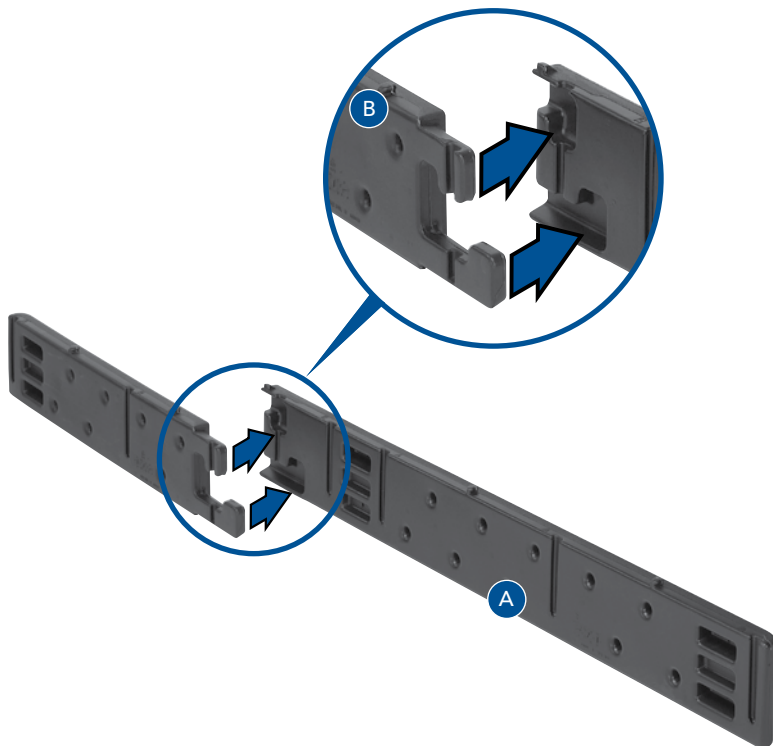

2 PINS

- Insert pins by sliding into beams in the direction of the arrow
- Push firmly
- Make sure that the top of the pin is flush with the top of the rail

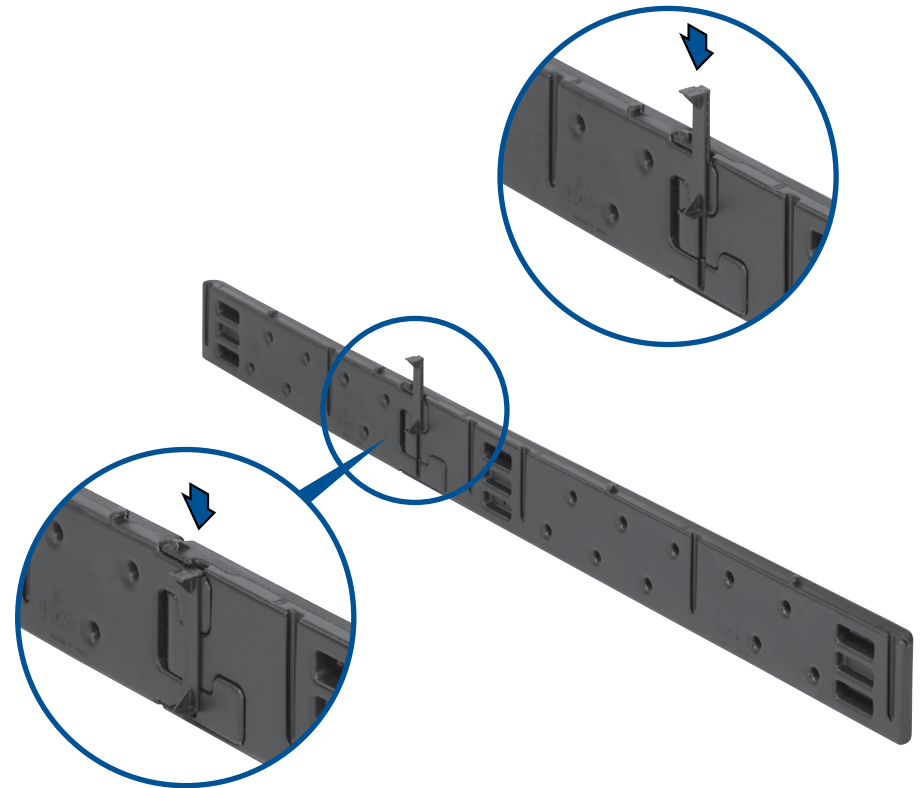

If you've purchased base legs, install them now, before inserting support and end beams. (See package for instructions.)

3 SUPPORT/END BEAMS

Match "A" end of the support/end beam with the "A" groove of the side rail. Match "B" end of the support/end beam with the "B" groove of the side rail

For Twin, Twin Long, Queen, Expanded Queen and King beds:

- Slide 2 of the beams labeled "support beam" into each end of the side rails ensuring the tabs are pointed up; push firmly until top is flush; joints fit tightly

For Full, Double and California King beds:

- Slide 2 of the beams labeled "end beam" into the side rails ensuring the tabs are pointed up; push firmly until top is flush; joints fit tightly

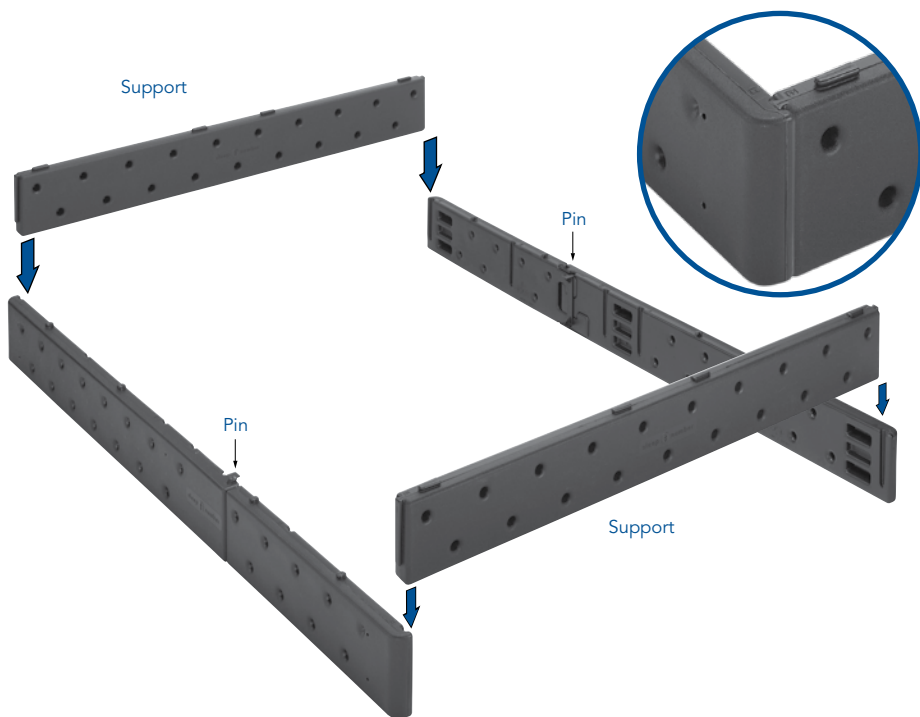

Expanded Queen beds only

Attach a corner bracket over each end beam before connecting to the side rail.

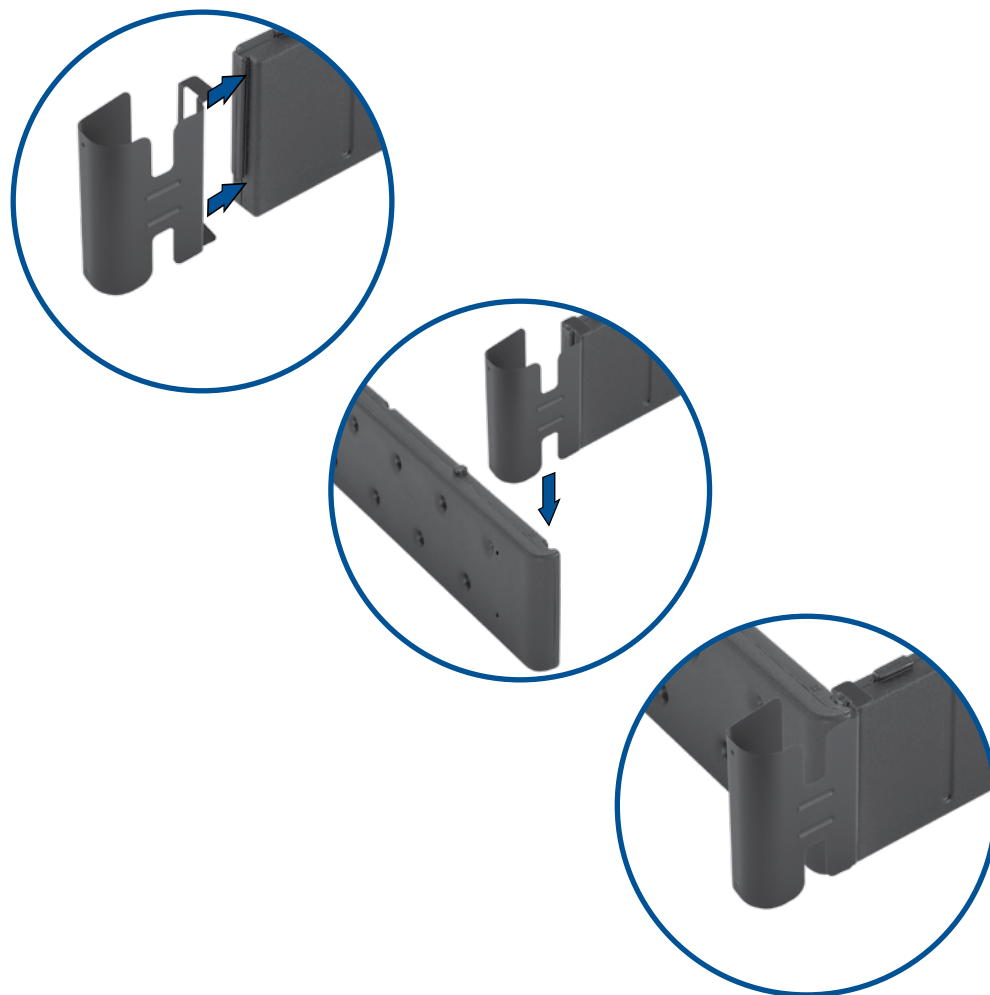

BASE ASSEMBLY

4 SUPPORT BEAMS

- Slide the support beams into grooves in the side rails, ensuring the tabs are pointed up; push firmly until top is flush; joints fit tightly

- Slide the remaining support beams into the next set of channels

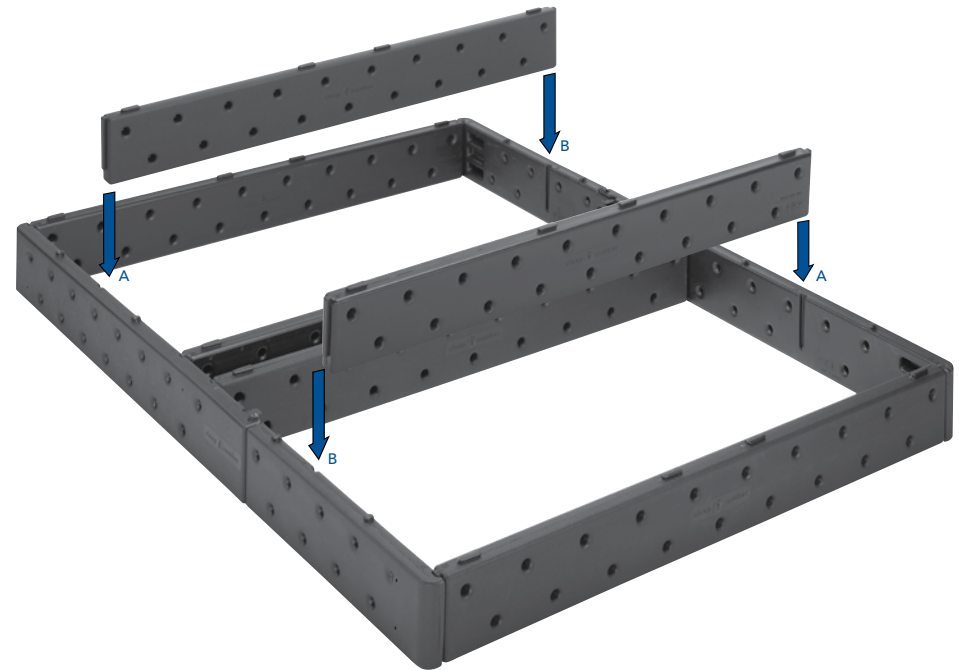
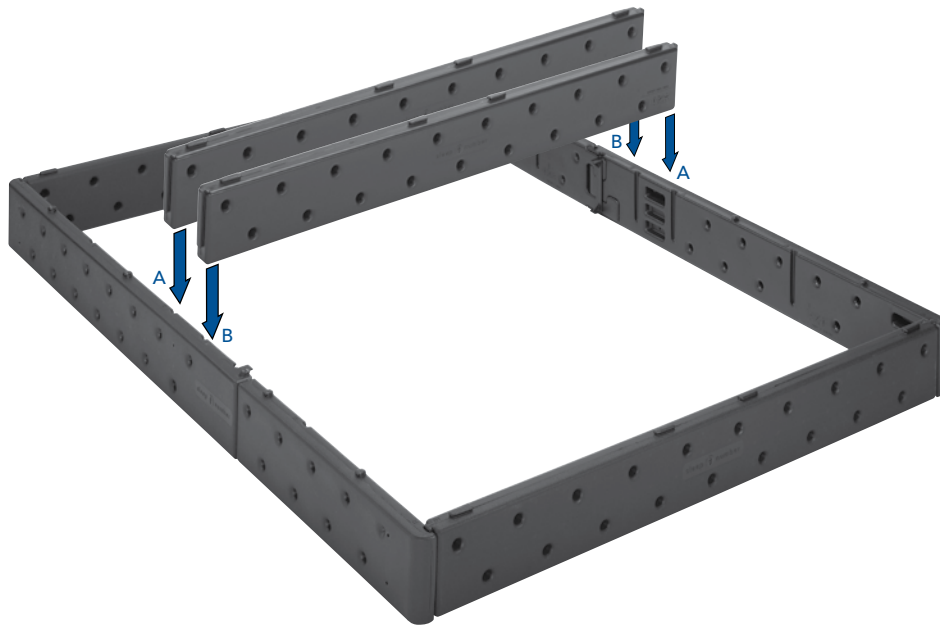

5 DECK PANELS

- Slide deck panels onto frame from outside in, locking each panel into place by securing it to the tabs of the frame and beams
- Ensure the deck panels are flush on all sides
- Panels fit snugly, do not force

Reminder: King and California King bases consist of two bases, side by side.

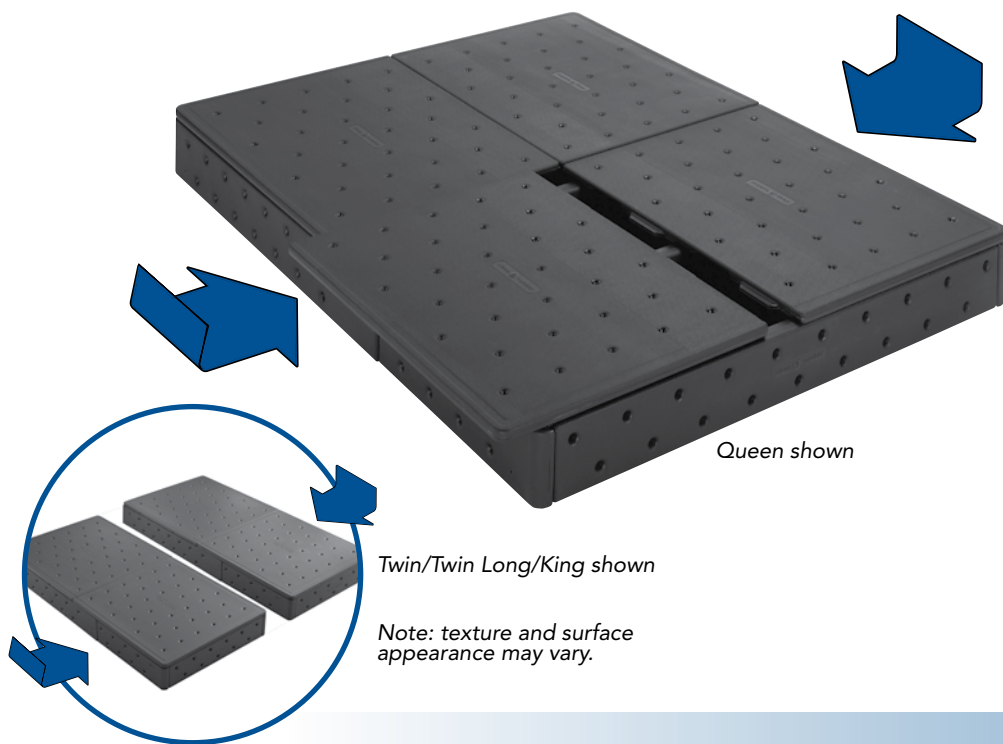

6 COVERLET

- Place coverlet on top of base.
- Carefully cover one corner at a time, positioning the seam at the head of the bed

Expanded Queen coverlet will go over the corner brackets.

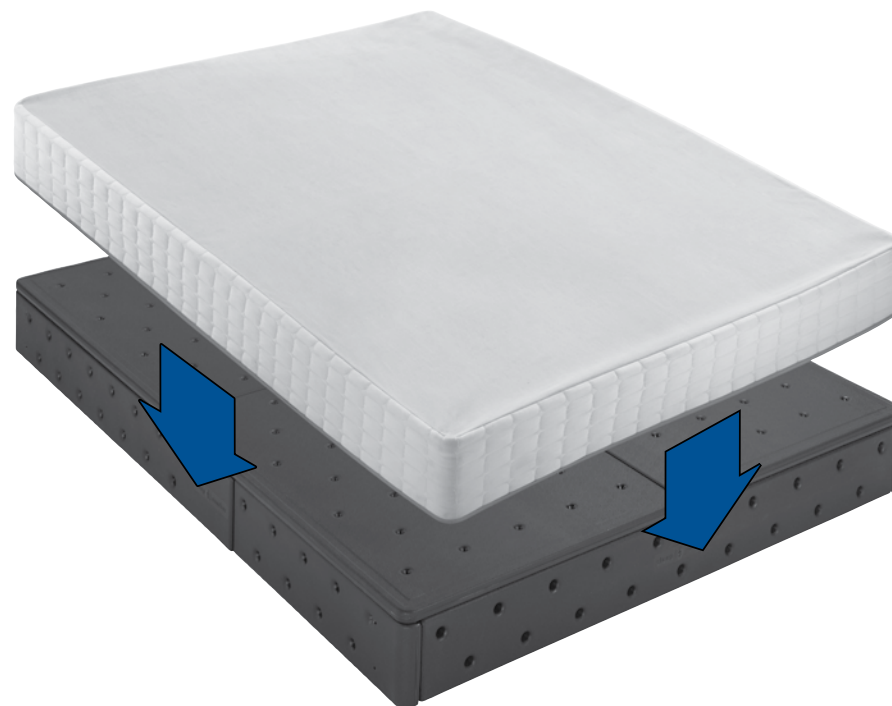

YOU'RE DONE! NEXT STEP ► MATTRESS ASSEMBLY

"This is the first time in three years that I slept through the entire night without getting up two or three times. I'm thrilled and amazed! Unbelievable! I wish we had purchased your sleeping system years ago."

- Keith F., Jackson, MI

BEFORE YOU BEGIN YOUR MATTRESS ASSEMBLY

▶ Carefully check the contents of your mattress boxes

▶ **IMPORTANT NOTE** Prepare your foam pad(s)

Carefully open the foam comfort pad(s) and set aside.

At least 20 minutes of expansion time is needed.

▶ **Orientation**

These instructions refer to "left" and "right" as if you are lying on your back on the bed looking toward the foot of the bed.

▶ **Using a Surge Protector**

While the Firmness Control™ system may be plugged directly into a wall outlet, we recommend using a surge protector to guard against unexpected power surges. We recommend using a surge protector that is listed to UL® 1449 with a clamping voltage of 330 volts, and a joule rating of 700 or higher.

Please note: Your 20-Year Limited Warranty does not cover damage to the Firmness Control™ system due to a power surge, regardless of the source. See the Limited Warranty for more details.

If you are missing any items listed on the following page, please call 1.800.472.7185 or e-mail Customer Service at customerservice@selectcomfort.com



MATTRESS PARTS AND COMPONENTS

Twin/
Twin Long/Full Double/Queen/
Expanded Queen King/
California King

Mattress Cover

Color and pattern will vary by bed

Shown as packaged



1

1

1

Foam Border Walls

Two long and two short

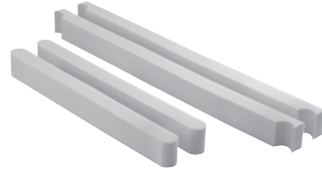

4

4

4

Air Chambers



1

2

2

May be in one package

May be in one package

Firmness Control™ System with Remote



1

1

1

Center Foam Wall

Dual Chamber beds only

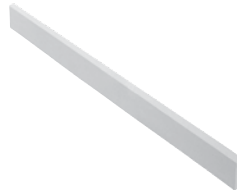

0

1

1

Foam Comfort Pad*

Color and pattern may vary

Shown as packaged.

*Not included in Sleep Number c2 bed.

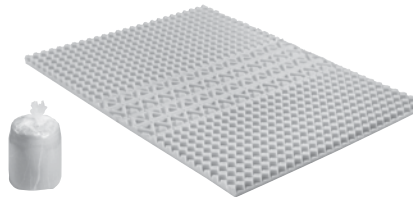

1*

1*

1*

MATTRESS ASSEMBLY



MATTRESS ASSEMBLY

REMEMBER: Open the foam comfort pad(s) before you begin and let expand for 20 minutes.

1 MATTRESS COVER

- Place on base or on existing bed platform

Make sure the holes in the bottom of the cover are at the head of the bed.



2 MATTRESS COVER TOP

- Unzip and set cover top aside

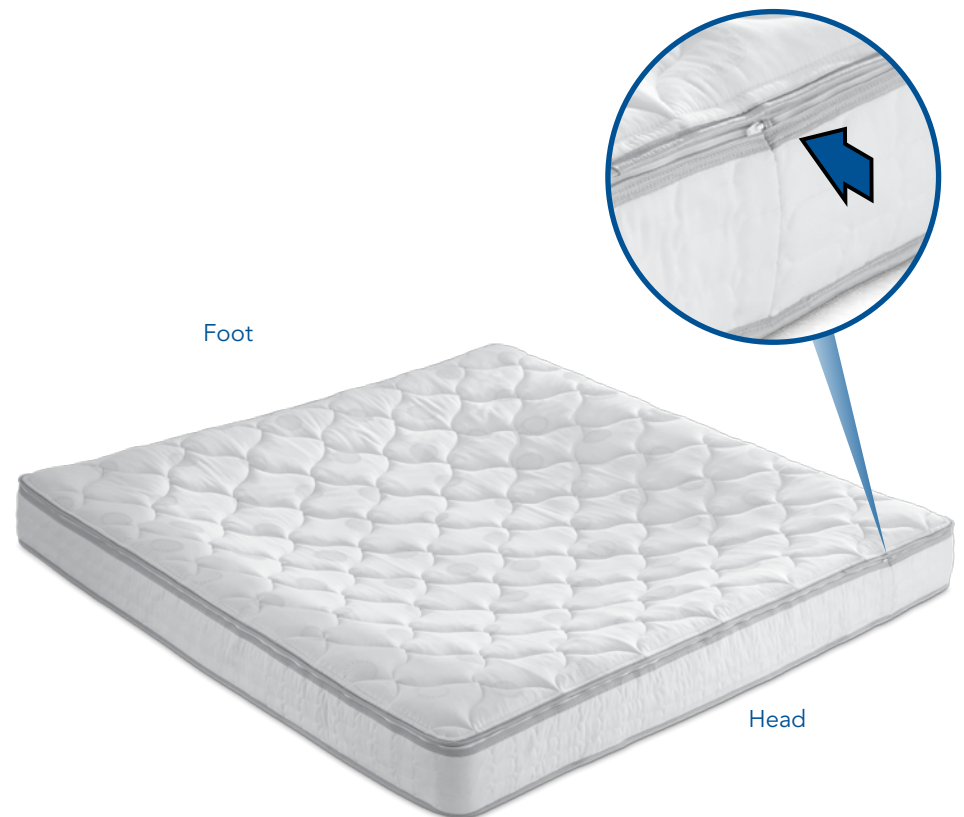

Cover color and pattern may vary.



3 FOAM SIDE WALLS

- Place long border walls along sides, extending the entire length of the bed. Ensure that the edge is aligned against the cover wall, notches facing the center of the bed

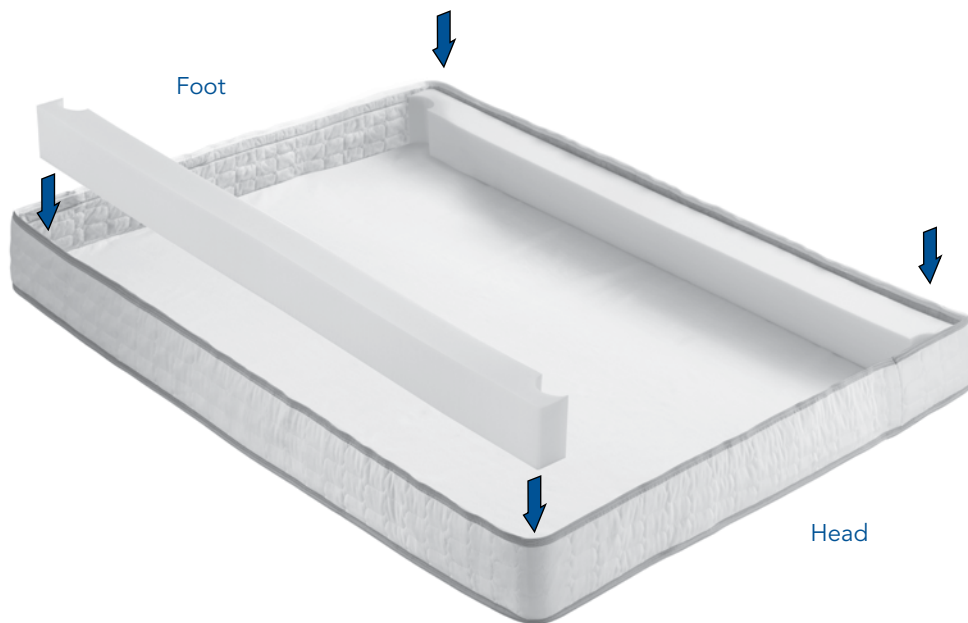

4 FOAM END WALLS

- Place short border walls at the head and foot, between the side walls

Make sure the foam border walls are connected securely and squarely



MATTRESS ASSEMBLY

5 AIR CHAMBERS

- Place air chambers so the hose connectors lie on the bottom when inflated and the connectors face the head of the bed

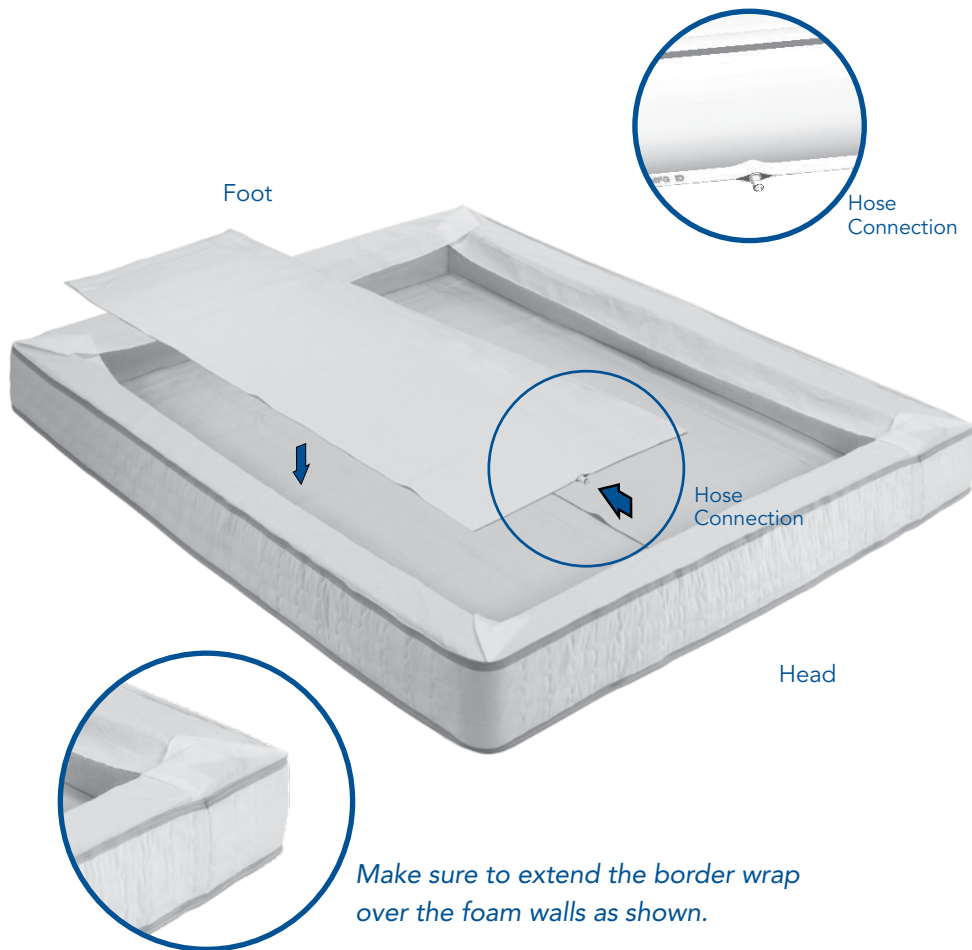

6a FIRMNESS CONTROL™ SYSTEM FOR DUAL CHAMBER BEDS

- Place the Firmness Control™ system on the floor at the head of the bed
- Plug the power cord into the Firmness Control™ system and into an outlet

Key Step: Pass the hose marked "L" through the hole on the left side of the mattress cover and connect to the left air chamber

- Press hose connections together until they click
- Complete the same hose connection process on right side

TO CALIBRATE:

1. Unplug and re-plug your Firmness Control™ system into an outlet.
2. While **standing** next to the bed choose L or R to initiate one side of the bed, and then press and hold the firmer ▲ arrow to reach a SLEEP NUMBER® setting of 100.
3. Once the chamber has reached 100 use the softer ▼ arrow to reach a *Sleep Number* of 50.
Note: During this exercise the *Sleep Number* reading may fluctuate.
4. Repeat Steps 2 and 3 one more time for the initial chamber.
5. Repeat Steps 2 and 3 twice for the second chamber.

NOTE: The warranty does not cover damage to the Firmness Control™ system due to a power surge. Using a surge protection device (not included) is recommended.



6b FIRMNESS CONTROL™ SYSTEM FOR SINGLE CHAMBER BEDS

- Place the Firmness Control™ system on the floor at the head of the bed
- Plug the power cord into the Firmness Control™ system and into an outlet
- Pass the hose through the hole in the mattress cover and connect to the air chamber
- Press hose connections together until they click

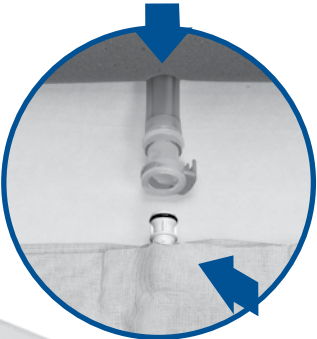

Foot



Store air chamber caps inside mattress at head of bed.

*Dual chamber mattress shown.

TO CALIBRATE:

1. Unplug and re-plug your Firmness Control™ system into an outlet.
2. While **standing** next to the bed, press and hold the firmer ▲ arrow to reach a SLEEP NUMBER® setting of 100.
3. Once the chamber has reached 100 use the softer ▼ arrow to reach a *Sleep Number* of 50.
Note: During this exercise the *Sleep Number* reading may fluctuate.
4. Repeat Steps 2 and 3.

NOTE: The warranty does not cover damage to the Firmness Control™ system due to a power surge. Using a surge protection device (not included) is recommended.

MATTRESS ASSEMBLY

7 CENTER FOAM WALL (DUAL CHAMBER BEDS ONLY)

- Insert center foam wall between the air chambers



8 FOAM COMFORT PAD*

- Place the foam comfort pad on top of the air chambers

*Not included with Sleep Number® c2 bed.

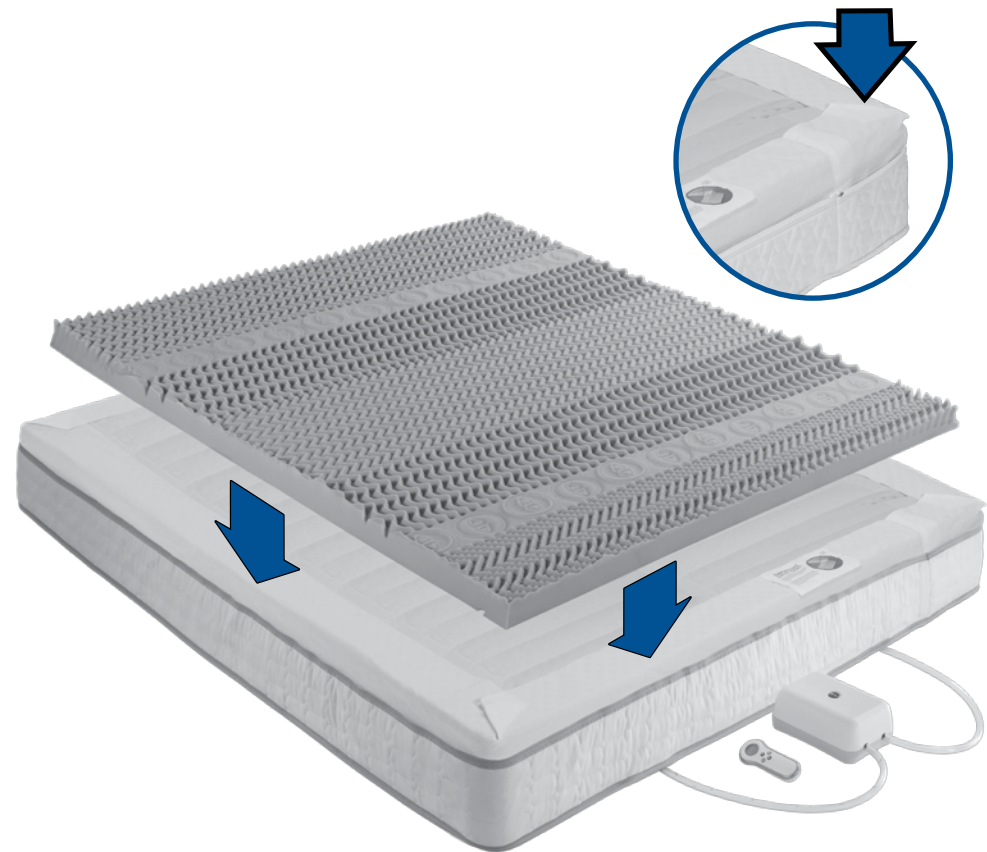

IMPORTANT SAFETY NOTICE:

Make sure the patterned side is up. Then extend the border wrap over the foam comfort pad as shown.

9 BORDER WRAP POSITIONING

- Verify that the border wrap extends over the foam comfort pad

IMPORTANT SAFETY NOTICE: To ensure compliance with federal and state flammability requirements, the border wrap must be positioned correctly within the mattress as shown.

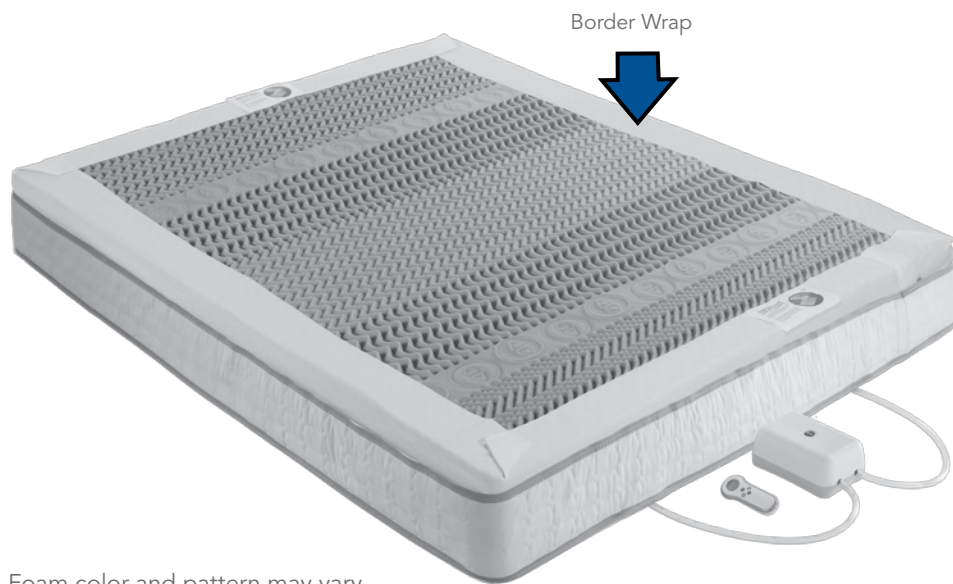

Foam color and pattern may vary.

10 MATTRESS COVER TOP

- To close mattress cover, place cover top on bed and ensure zipper pull is at head of bed.
- Make sure the zipper pin is completely inserted into the zipper box. Zip the top of the mattress cover closed

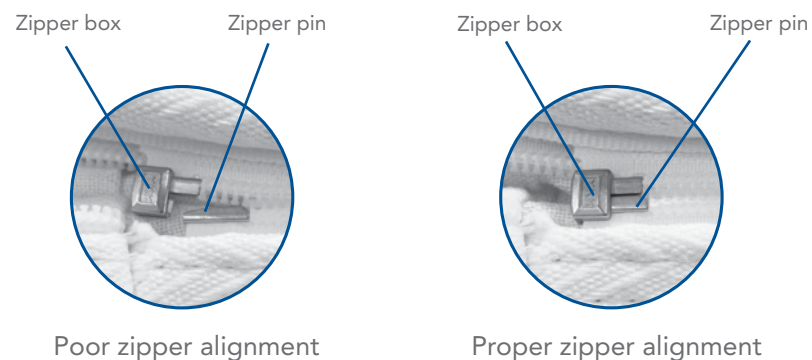

YOU'RE DONE! NEXT STEP ► FIRMNESS CONTROL™ SYSTEM



YOUR REMOTE AND ITS FUNCTIONS

Single Chamber



Firmer

Softer

wakes when any button is pressed

Dual Chamber



Firmer

Side

Softer

wakes when L or R button is pressed

A 9-Volt battery is included and should last about six months under normal use. Replace the battery when the low battery indicator is displayed.

BUTTON	FUNCTION
Firmer ▲ Softer ▼	Press and release the ▲ or ▼ button several times until desired SLEEP NUMBER® setting is displayed. Adjustment will begin after a slight delay.
Side (L) and (R)	Press to choose a side, it will display the previous <i>Sleep Number</i> setting.

WHAT IS A SLEEP NUMBER® SETTING?

Your SLEEP NUMBER® setting is a number between 0-100 that represents the ideal combination of mattress comfort, firmness and support for your body, giving you the best night's sleep possible.

YOUR SLEEP NUMBER® SETTING

When you shopped for the SLEEP NUMBER® bed, you may have discovered your *Sleep Number* setting. You should use this as a starting point when setting the firmness of your SLEEP NUMBER® mattress. If you don't already have your *Sleep Number* setting or if you would like to experiment with finding a different *Sleep Number* setting, use the instructions provided on the next page.

Caution Statement: (per CFR 15.21) Changes or modifications not expressly approved by the party responsible for compliance could void the users authority to operate the equipment.

Device Statement: (Section 15.105 (b) of the FCC Rules) Note: This equipment has been tested and found to comply with the limits, pursuant to part 15 of the FCC Rules. These limits are designed to provide reasonable protection against harmful interference in a residential installation. This equipment generates, uses, and can radiate radio frequency energy and, if not installed and used in accordance with the instructions may cause harmful interference to radio communications. However, there is no guarantee that interference will not occur in a particular installation. If this equipment does cause harmful interference to radio or television reception, which can be determined by turning the equipment off and on, the user is encouraged to try to correct the interference by one or more of the following measures:

- Reorient or relocate the receiving antenna.
- Increase the separation between the equipment and receiver.
- Connect the equipment into an outlet on a circuit different from that to which the receiver is connected.
- Consult the dealer or an experienced radio/TV technician for help.

This device complies with Part 15 of the FCC Rules. Operation is subject to the following two conditions: (1) this device may not cause harmful interference, and (2) this device must accept any interference received, including interference that may cause undesired operation.

Important Safety Instructions

- **WARNING**—To reduce the risk of fire or electric shock, do not use this Firmness Control™ system with any solid-state speed control device.
- No user serviceable parts are included. For service needs, contact Select Comfort Customer Service.
- Protect the Firmness Control™ system against water ingress.
- Certain Firmness Control™ systems have a polarized plug (one blade is wider than the other). To reduce the risk of electric shock, this plug is intended to fit in the polarized outlet only one way. If the plug does not fit fully into the outlet, reverse the plug. If it still does not fit, contact a qualified electrician. Do not attempt to defeat this safety feature.

FIND YOUR SLEEP NUMBER® SETTING

- ▶ **Step 1 — Ready** - Lie down in your favorite sleeping position and adjust your pillow to your liking. Using your remote, change your *Sleep Number* setting to 100 (firmest), and then down to 20 (very soft).
- ▶ **Step 2 — Set** - Now, set your *Sleep Number* back to 100. As the mattress gets firmer, how do your neck, shoulders, hips and back feel? When you feel comfortably supported, stop. Make adjustments up or down by 5-10.
- ▶ **Step 3 — Sleep** - Try sleeping at this setting for 2-3 nights. If you need to make an adjustment, change your number by 5-10, and try this new setting for 2-3 nights.

EVALUATING YOUR COMFORT LEVEL

As you are customizing the *Sleep Number* bed for your optimum comfort level, you will want to evaluate your sleep position and determine how you feel as compared to the diagrams shown to the right, then make adjustments to your firmness or pillow if needed. Your pillow should help keep your body aligned properly, otherwise it may interfere with your ability to sleep comfortably. Visit sleepnumber.com or one of our stores to get fit for a perfect pillow and see the extensive selection of innovative pillows we carry for all sleep positions and fill preferences.

RIGHT



- Neck and back are aligned in the same position as when you are upright.
- No discomfort at shoulder and hip pressure points.
- You feel the mattress support the small of your back (back sleepers) or the curve of your side (side sleepers).

WRONG



- Body alignment is not straight.
- Your pillow makes your head tilt at an angle to the rest of your body.
- You feel discomfort from pressure at your neck, shoulders, back, hips or legs.

GIVE IT TIME

It sometimes takes several nights of sleeping at different settings to discover your ideal *Sleep Number* setting. If you would like to experiment further with your *Sleep Number*, you may want to consider keeping a sleep journal. When you have found a *Sleep Number* setting where you feel comfortable, log this number into your sleep journal. Try to sleep at this *Sleep Number* setting for three to four nights, adjusting in increments of 5 or 10 only. It will take your body that long to become accustomed to a new sleep surface. After five nights, reevaluate your comfort level and log the new setting into your sleep journal, adding comments if helpful. Repeat the process until you have found the perfect setting for you.

If, after trying four different Sleep Number settings, you have not found your ideal Sleep Number setting and would like additional assistance, go to sleepnumber.com and click on Customer Service or call 1.800.472.7185 to reach a Customer Service Representative. Our trained Customer Service Representatives will provide solutions to improve your comfort. Your sleep is our expertise.



THINGS TO REMEMBER

► Reasons to alter the firmness of your bed

- strained muscles
- back pain
- weight change
- pregnancy
- sunburn
- new sleep position

as well as

- to facilitate getting out of bed, if needed
- to achieve a fuller bed appearance

► Dual Adjustability

If you purchased a dual chamber bed, you have the ability to personalize each side of your SLEEP NUMBER® bed. Since no two body types are the same, each sleep partner should find their own comfort level.

If your bed came with one remote for a dual chamber bed, the “L” button on the remote corresponds to the left side of the bed (left is determined when lying on your back on the bed). The “R” button corresponds to the right side.

Sleep Number® setting study

As you can see, *Sleep Number* bed owners find comfort at all settings from 0–100, however the majority of sleepers find their SLEEP NUMBER® setting between 35–50.

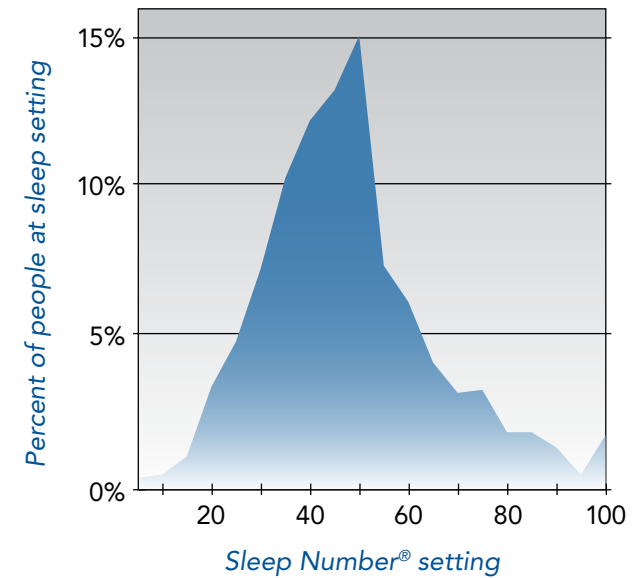

MATTRESS CARE

The cover of your SLEEP NUMBER® mattress may be spot cleaned with carbonated water. Do not dry clean the mattress cover or put it in a washing machine. Also, please do not apply stain guard, as it may cause yellowing of the fabric.

SLEEP NUMBER is a leader in the industry in the use of materials designed to inhibit the growth of allergens or microorganisms that, in rare circumstances, can form inside any mattress, bedding, pillow or upholstered product.

Advanced antimicrobial safeguards are incorporated into every SLEEP NUMBER® bed. Key components of the mattress have been treated to protect the bed from contaminants such as mold, mildew and bacteria growth. The unique, zip-open design of the *Sleep Number* bed allows you to easily open, ventilate or vacuum if you choose.

In rare instances under the right conditions, mold or mildew can form inside many types of mattresses, bedding or upholstered products. Should this condition occur in your mattress, please contact our Customer Service department at 1.800.472.7185 so we can work with you to return your bed to factory-fresh condition.

TRANSPORTING YOUR SLEEP NUMBER® BED

Your *Sleep Number* bed is lighter than any conventional bed, making it much easier to move.

Moving it yourself

- The base should always be disassembled. Bag all hardware so that it is not lost.
- If you have a full-size mattress moving box, the mattress can remain fully inflated, capped off and packaged.
- If you don't have a mattress box, the cover and foam should all be double bagged to prevent stains. The chambers should be deflated and boxed to prevent possible abrasions and other damage.
- The Firmness Control™ system should be packed in a box, surrounded by some sort of packing material if the original box is not available.
- The remote, caps and instructions should be tucked in the box with the pump to prevent them from being lost.

Using a moving company

- The base should always be disassembled. Bag all hardware so that it is not lost.
- The mattress can be fully inflated, capped off, and should be packaged in a mattress box for moving.
- The Firmness Control™ system should be packed in a box, with packing material, and transported in a manner where it will be exposed to minimal shock and vibration.



Like our SLEEP NUMBER[®] beds, our exclusive SLEEP NUMBER[®] Bedding Collection offers a complete line of products with solutions to meet the unique comfort needs of you and your partner. From the way your head rests on your pillow to the warmth you prefer, our bedding is designed to fit your bed, your sleep, your life.

SOLUTIONS FOR EVERY NEED

- Discover Better Sleep with Your Perfect Pillow. Experience PillowFit[®]
- Temperature Balancing
- Natural Allergy Defense
- All Natural
- Health and Wellness
- Warming



Create the perfect

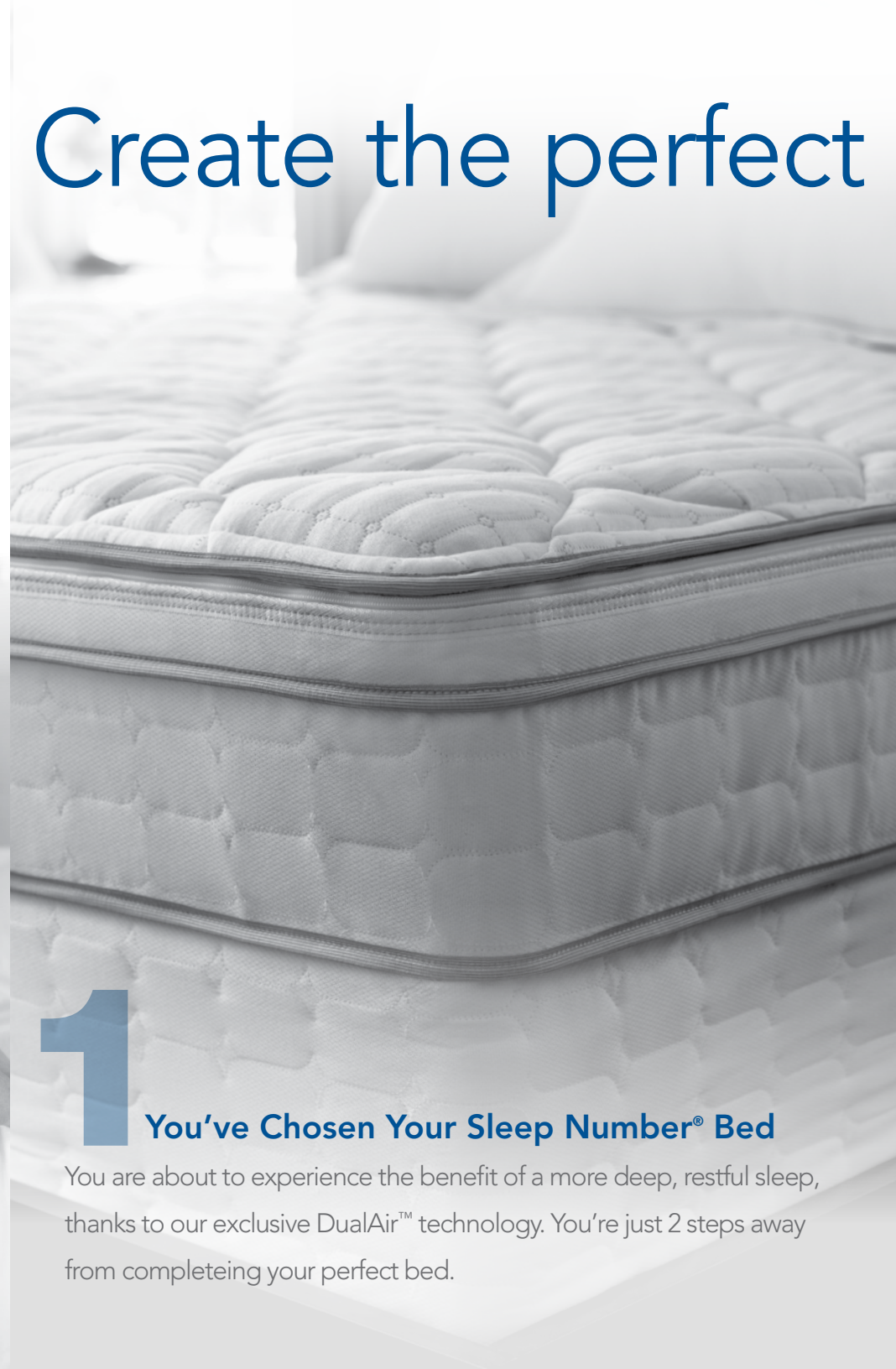

1

You've Chosen Your Sleep Number[®] Bed

You are about to experience the benefit of a more deep, restful sleep, thanks to our exclusive DualAir[™] technology. You're just 2 steps away from completing your perfect bed.

bed for you. It's as easy as **1, 2, 3.**



2

Find Your Perfect Sleep Number® Pillow

Discover better sleep with your perfect pillow. Experience PillowFit® and let our Sleep Professionals help you find the right pillow for you.



3

Choose Your Sleep Number® Bedding

Our SLEEP NUMBER® Bedding Collection offers exclusive innovations designed to improve your sleep. Create your personal sleep experience and wake up rested and renewed.



WARRANTY AND INNERCIRCLESM

SHARE THE BENEFITS

Improve the lives of friends and family by sharing what you love about your SLEEP NUMBER[®] bed. It's as easy as 1, 2, 3.

1. **Exclusive Discounts** Visit us online at sleepnumber.com/innercircle for coupons.
2. **Pass along** Share discounts with your friends, family and coworkers.
3. **Earn rewards** You get rewarded every time a friend purchases a bed.

WATCH THE REWARDS ADD UP

The more referrals who purchase a bed, the more rewards you can earn. Use them toward any SLEEP NUMBER[®] products you choose—pillows, a new comforter, a mattress pad, even a new bed. There are no forms to fill out or paperwork to track. We take care of it all!

RETURN POLICY

We are confident that you will be completely satisfied with your *Sleep Number* bed. Please take into consideration that it may take several weeks to adjust and get completely comfortable. After 30 days, if for any reason you decide to return the bed, contact Customer Service before packing your bed. Simply call us toll-free within 45 days of delivery to authorize its return. Upon receipt, we'll reimburse the full purchase price less your initial shipping or Home Delivery and Setup fees. You pay return shipping. There are no returns or exchanges on adjustable bases, closeout or demo bed models. All merchandise being returned must be in good condition and be given a Return Merchandise Authorization number from Customer Service, which will expire 30 days from date of issue. All refunds will be issued to the original method of payment within approximately

15 business days after all products have been received at SLEEP NUMBER. All shipping and incidental charges to return the bed are the customer's responsibility.

DEFECTIVE OR DAMAGED COMPONENTS

If any component of the mattress or base is found to be defective in materials or workmanship within first two years of the original purchase date, they will be replaced by *Sleep Number* at no cost to you. Within the first two years, all shipping charges to replace a defective component will be covered by *Sleep Number*. If any component of the mattress or base is found to be defective in materials or workmanship after two years from the original purchase date, the terms of the Limited Warranty will apply. After two years from the date of purchase, you will be responsible for the cost of shipping the defective component back to *Sleep Number* and any related costs. Contact our Customer Service department at 1.800.472.7185 for troubleshooting assistance and if you need to process the replacement order.

We recognize that components may break, become soiled or unusable and may not be covered under the warranty. In the event that replacement components are required or if you wish to upgrade to newer components, you may purchase these items by simply providing proof of purchase. All component sales are final and carry a 2-Year Limited Warranty from the purchase date. Product discounts and bedding promotions do not apply to components. Call our Customer Service department for current pricing and to process the component purchase.

LIMITED WARRANTY

What is covered:

- Select Comfort ("SLEEP NUMBER") provides a limited warranty for your mattress and/or base. The limited warranty provides protection from defects in materials and workmanship for a period of 20 years from the original purchase date. Warranty is limited to product repair or replacement only.

What we will do:

- *Sleep Number*, at its option, will repair or replace the warranted product or component at a cost to the original purchaser based on the following table. The "price" is the price of the warranted product or component at the time the warranty claim is made, or the price of a comparable product or component if the original product or component is no longer in production.

Years after purchase date	Original purchaser's cost
Up to 2 years	No Cost
2-20 years	20% plus 4% of price for each year from original purchase date.

- For example, if a warranty claim arises 12 years after the original purchase date, the cost to the original purchaser would be 68% of the price (that is, 20% plus 4% for each of the 12 years) and *Sleep Number* would be responsible for the remaining 32% of the price.
- *Sleep Number* reserves the right to substitute products or components of equal or better quality, and to use or deliver refurbished products or components in the repair or replacement of any product under this Limited Warranty.

What is not covered:

- Conditions arising from normal wear and tear. (Conditions arising from normal wear and tear include, but are not limited to: mattress cover compression, foam compression, or discoloration of components.)
- Damage from tampering with any component or from opening the Firmness Control™ system.
- Damage from misuse or abuse of the warranted product or component.
- Damage from laundering or dry-cleaning.
- Acts of God, such as but not limited to lightning damage.

What you must do:

- Return the warranted product or component in sanitary condition to an authorized SLEEP NUMBER® service center. *Sleep Number* will incur the cost of shipping up to two years after the original purchase date; after two years, the return shipping to *Sleep Number* will be at the customer's expense.
- Please telephone our Customer Service department at the number on the back cover to locate the nearest authorized service center and arrange for the return of the warranted product or component.

What will void this warranty:

- Tampering with any component or opening the Firmness Control™ system and its hand control unit.
- Misuse or abuse of the warranted product or component.
- Sale, transfer or other disposal of the warranted product or component.

Limitations:

- Your exclusive remedy, IN LIEU OF ALL INCIDENTAL, SPECIAL OR CONSEQUENTIAL DAMAGES, INCLUDING FOR NEGLIGENCE, is limited to repair or replacement of any product or component deemed to be defective under the terms and conditions stated above. *Sleep Number* will bear no other damages or expenses.
- Customer maintains responsibility for installation of parts replaced under terms of the warranty.
- *Sleep Number* reserves the right to refuse to repair or replace any product or component that is returned in an unsanitary condition.
- Warranty for exterior surfaces against stains and soil is limited to manufacturer's defect only, within the first 30 days of delivery. No other warranty coverage against stains and soils is included.
- This Limited Warranty applies only to the product as used in the United States and Canada. It is not applicable in U.S. territories or other countries.
- This Limited Warranty is non-transferable.
- Repair or replacement of a product or component under the terms of this Limited Warranty in no way lengthens the Limited Warranty period.
- ANY IMPLIED WARRANTIES APPLICABLE TO THIS PRODUCT, INCLUDING ANY WARRANTIES OF MERCHANTABILITY OR FITNESS FOR A PARTICULAR PURPOSE, ARE LIMITED IN DURATION TO THE DURATION OF THIS WRITTEN LIMITED WARRANTY.

Some states do not allow the exclusion or limitation of incidental or consequential damages, or limitations on how long an implied warranty lasts, so the above limitations may not apply to you. This warranty gives you specific legal rights and you may also have other rights, which vary from state to state.

All claims relating to the Limited Warranty of SLEEP NUMBER® products should be made by contacting Customer Service at at the number on the back cover or writing to Sleep Number Customer Service, 6105 Trenton Lane North, Minneapolis, MN 55442.

FIRMNESS CONTROL™ SYSTEM NOTIFICATION

Caution Statement: (per CFR 15.21) Changes or modifications not expressly approved by the party responsible for compliance could void the users authority to operate the equipment. Device Statement: (Section 15.105 (b) of the FCC Rules) Note: This equipment has been tested and found to comply with the limits, pursuant to part 15 of the FCC Rules. These limits are designed to provide reasonable protection against harmful interference in a residential installation. This equipment generates, uses, and can radiate radio frequency energy and, if not installed and used in accordance with the instructions may cause harmful interference to radio communications. However, there is no guarantee that interference will not occur in a particular installation. If this equipment does cause harmful interference to radio or television reception, which can be determined by turning the equipment off and on, the user is encouraged to try to correct the interference by one or more of the following measures:

- Reorient or relocate the receiving antenna.
- Increase the separation between the equipment and receiver.
- Connect the equipment into an outlet on a circuit different from that to which the receiver is connected.
- Consult the dealer or an experienced radio/TV technician for help.

This device complies with Part 15 of the FCC Rules. Operation is subject to the following two conditions: (1) this device may not cause harmful interference, and (2) this device must accept any interference received, including interference that may cause undesired operation.





BASE FAQ'S

Q. What if I can't get my center support beams flush with the side rails?

- A. Make sure the letter on the center support beam matches the side rail. For example, the end of the center beam labeled "A" should connect to the side rail with the "A" on it. Additional force may be required.

Q. How can I get my pins in all the way?

- A. All pins are wider at one end and narrower at the other end. Make sure the "T" end is up and the narrow end goes into the side rail first. You may need to use a bit of force to get it in place.

Q. What can I do if I can't get the deck panels to lay flat?

- A. First, make sure all the pins and beams are flush. Then, set the deck panel over the notches. You should then be able to slide the panel into place.

Q. Where is the hardware for the footboard and headboard brackets?

- A. The same hardware for attaching the legs to the base is used for attaching the brackets.

MATTRESS FAQ'S

Q. Where are the caps for air chamber(s)? And where should I store them?

- A. The caps are in the Firmness Control™ system box. Please store these in the mattress cover in case you should ever want to disassemble your bed and temporarily cap your air chamber(s).

Q. What if my foam comfort pad appears to be too small or irregular?

- A. Gently shake the pad as you place it on your mattress and it will recover its full size overnight.

Q. What if I feel like I'm rolling toward the edge or toward the center of the mattress?

- A. Although rare, these sensations could potentially be experienced if one side of the mattress is set quite firm and the other side quite soft. Call Customer Service for a remedy to this situation if it is bothersome to you.

Q. What if I notice a rubber smell from the air chamber?

- A. The odor you may smell is non-toxic and will fade over time. To minimize the smell, unzip the mattress cover and allow the air chamber to air out for a few hours. Laying a couple of dryer sheets on top of the air chamber will also help mask any odor by adding a fresh scent.

Q. Why are there body impressions on the mattress cover?

- A. For the best looking, most crisp appearance, customers should fully inflate the mattress (if using a digital SLEEP NUMBER® remote). If going to full inflation does not help with body impressions in the cover, the quilted top can be removed and shaken to restore some of the loft to the fiberfill. In addition, a vacuum nozzle may be used to fluff the cover in areas where the fibers have settled from use.

Body impressions in a normal innerspring mattress would be an indication that the spring support is compressing or breaking down. The SLEEP NUMBER® bed uses air to support your body. Since air cannot break down, you receive the same support after years of use as you do on the first day of use.

FIRMNESS CONTROL™ SYSTEM FAQ'S

Q. Why does my Sleep Number® setting change?

- A. There are several factors that can contribute to fluctuations in a SLEEP NUMBER® setting. A *Sleep Number* setting is based on the combination of body weight, volume of air in the air chamber and sleep position.
- Temperature: An increase or decrease in temperature can cause changes in a *Sleep Number* setting. A heated mattress pad will cause the *Sleep Number* setting to increase.
 - Barometric Pressure: Changes in atmospheric pressure related to weather and altitude can cause your *Sleep Number* setting to change.
 - Weight: The Firmness Control™ system acts similarly to a scale; more weight means a higher *Sleep Number* setting. In addition, the way that the weight is distributed will affect the reading.
 - Sleep Position: The more concentrated the weight is, the greater chance the *Sleep Number* setting will be higher (i.e., when you lie on your side). When it is distributed throughout the chamber more, it is more likely that the *Sleep Number* setting will be lower (i.e., when you lie on your back or stomach).

Q. What do I do if the Firmness Control™ system doesn't run?

- A.** Make sure the power cord is securely plugged into the Firmness Control™ system and the wall outlet. Check to see if the power cord is plugged into an outlet that has power and is not connected to an on/off wall switch.

Q. I feel the mattress is losing air. What should I do?

- A.** Air loss can be caused by an unsecure hose connection, a defective air chamber, or a defective Firmness Control™ system. First, make sure the air hoses are securely connected to the air chambers. If you do not find any damaged or loose connections then please identify which situation below matches your situation and follow the instructions for remedying your issue.

NOTE: To avoid variations in your SLEEP NUMBER® setting or level of comfort, make sure that you are lying in your normal sleep position when adjusting and checking your *Sleep Number* setting.

If you have a dual air chamber bed and suspect only one (1) side of your Sleep Number® bed is getting softer...

- Inspect the o-ring and connectors for cracking or damage.
- Switch the air hoses on the air chambers so the Left hose (labeled as L on the Firmness Control™ system hose) is attached to the Right air chamber and the Right hose (no labeling on the hose) is attached to the Left air chamber. You should hear a click when the air hose is securely connected into the air chamber.
- Fill the air chambers to the appropriate *Sleep Number* setting(s) for the person sleeping on each side of the bed.
- Sleep on the bed and monitor the feel of the bed's firmness on both sides.
- If neither chamber feels softer over time, you may have had a loose connection that was fixed during the switching of hoses. Switch the hoses back to their correct positions and continue to use the bed as normal.
- If an air chamber feels softer after switching air hoses, please contact Customer Service with the results (the issue stayed on the same side of the bed or it moved to the other side after switching hoses).

If you have a dual air chamber bed and both (2) air chambers are getting softer or have a single air chamber bed and feel the air chamber getting softer...

- Inspect the o-ring and connectors for cracking or damage then reconnect the Firmness Control™ system to the air chamber(s).
- Lie down in your normal sleep position and fill the air chamber(s) with suspected air loss to your normal *Sleep Number* setting plus an additional 15 points (i.e., if you sleep at 35, fill to 50). We ask that you over-inflate to compensate for air that may escape in one of the next steps.
- Locate the air chamber caps that came with your bed.*

- Remove the hose from the air chamber and quickly cap the chamber.
- Leave the air chamber(s) capped for a minimum of 48 hours.
- If the air chamber(s) become noticeably softer when capped, contact Customer Service.
- If the air chamber(s) hold air, reconnect the pump and continue using the bed. The air loss issue may have been due to environmental factors or a connection issue. Contact Customer Service if the air loss issue returns after reattaching the Firmness Control™ system.

*Caps are typically found at the head of the bed inside the mattress cover in a small plastic bag. If you cannot find the caps, they may be available at your nearest SLEEP NUMBER® store or can be requested by emailing CustomerService@selectcomfort.com with your address, or calling 1.800.472.7185.

Q. Will my bed deflate if there is a power surge or power loss?

- A.** No, your mattress will maintain its firmness. To protect your Firmness Control™ system, we do recommend using a surge protector.

Q. The wireless pump remote is displaying "Er." What is the problem?

- A.** An "Er" can be caused by several factors. The Firmness Control™ system base may not have power, or the remote and Firmness Control™ system base may have lost communication with one another.
- Make sure the Firmness Control™ system is firmly plugged into a working outlet and is receiving power. Is the outlet controlled by a wall switch? You will know that the unit has power if it "clicks" when you plug it in.
 - Make sure that the power cord is plugged into the side of the Firmness Control™ system.
 - Wait for the display to shut off (about 10 seconds). Then try to adjust the bed again. But this time, move the remote control a few inches to the left or right.
 - If the "Er" persists call Customer Service at the number on the back cover.

Q. Why does my Sleep Number® deflate past what I am trying to set it to?

- A.** Your Firmness Control™ system has software that it uses to inflate and deflate efficiently. If it is not deflating correctly the pump may have lost power or did not train properly when it deflated the first few times it was operated. See page 15 for a procedure that can correct this issue. This procedure should be done any time the pump has lost power.



Help is just a click or phone call away

If you ever have product questions or need additional assistance obtaining optimal comfort, please visit us at:

sleepnumber.com

or call

1.800.472.7185

Representatives are available
(Central Standard Time):

Monday–Friday 8am – 6pm

Saturday 8:30am – 5pm

Sunday Closed

connect with us on Facebook and Twitter



Facebook.com/SleepNumber



Beds.com/Twitter

sleep  number.

9800 59TH AVENUE NORTH
MINNEAPOLIS, MN 55442



116490

9/11

