



INNOVATION SERIES
LIMITED EDITION
BED ASSEMBLY GUIDE



Welcome

to Sleep Number

Congratulations on your purchase of the SLEEP NUMBER® bed. You've not only made a great decision to sleep your very best, you've joined the more than 8 million well-rested Insiders who are part of our InnerCircleSM family.

As an Insider, you'll be the first to know about our latest innovations and you'll always receive special savings on *Sleep Number* beds and bedding. You can even earn rewards for sharing what you love about your bed with friends and family.* Simply register your bed at sleepnumber.com/innercircle to start receiving all your exclusive benefits.

We believe the best sleep of your life begins with the Sleep Number® experience, and we look forward to further individualizing your comfort. Our 3,000 Sleep Professionals are dedicated to your sleep for life.

Sleep well, dream big.

Shelly Ibach

Shelly Ibach, President and CEO
My SLEEP NUMBER® setting is 35



* See Owners' InnerCircleSM Rewards Section for details. SLEEP NUMBER, SELECT COMFORT and the Double Arrow Design are registered trademarks of Select Comfort Corporation.

What's Inside

Setting up your new SLEEP NUMBER® bed only takes about an hour, but you'll enjoy the benefits of better sleep for years to come. You won't need any tools and, although it's nice to have a helper, you can do it by yourself.

Assembling Your Modular Base	pg 4
Assembling Your Mattress	pg 12
Individualizing Your Remote	pg 20
Getting Comfortable with Your Sleep Number® Setting	pg 22
Product Care	pg 24
Sleep Number® Bedding Collection	pg 26
Warranty	pg 28
Frequently Asked Questions	pg 30
Welcome to Sleep Number® InnerCircle SM	pg 34

Getting Started

Decide where to put your new bed. Make sure there's an electric power source nearby to operate your Firmness Control™ system.

You'll need a surge protector. Your 25-Year Limited Warranty does not cover damage to the Firmness Control™ system due to a power surge, regardless of the source. See the Limited Warranty on page 28 for more details.



Open all boxes. CAUTION: Immediately dispose of packaging as it can pose choking or other hazards to small children and pets.

Prepare your foam comfort layer(s). Foam comfort layer(s) should be stored at room temperature for at least four hours before mattress assembly. Carefully open the foam comfort layer(s) and set aside. They'll need at least 30 minutes to fully expand.

Before You Begin

Assembling Your Modular Base

Carefully check the contents of your base boxes.

Make sure you have the correct number of components for the size of bed you purchased. If you are missing any items listed to the right, please call 1.800.472.7185 or email Customer Service at customerservice@selectcomfort.com

Prepare your bed frame, if you have one.

You can assemble your base directly onto your current bed frame or on the floor. If your bed frame has slats, position them evenly to support the base. If it has fewer than three slats, we recommend adding more to ensure adequate support. For King beds, use slats if your frame does not have center support.

Set aside your Firmness Control™ system.

You'll need it during base assembly.

Modular Base: What's Included

	Twin Extra-Long	Full/ Double	Queen	King/ California King
Side Rails	2 Short 2 Long	2 Short 2 Long	2 Short 2 Long	4 Short 4 Long
Pins	2	2	2	4
Legs (optional)	6	6	9	12
Support/End Beams	6	6	6	12
Deck Panels	2	4	4	4
Coverlet	1	1	1	1

Modular Base Components

Side Rails

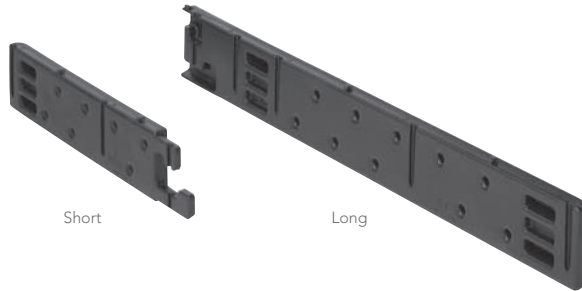

Pins



Legs
(optional)



Support/End Beams

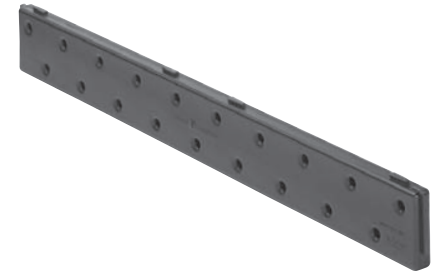

Deck Panels



Coverlet

(Shown as packaged)



Some texture and surface appearances may vary from those shown.

Assembling Your Modular Base

1 Side Rails

- Connect the short and long side rails.
- Push firmly; joints fit tightly.

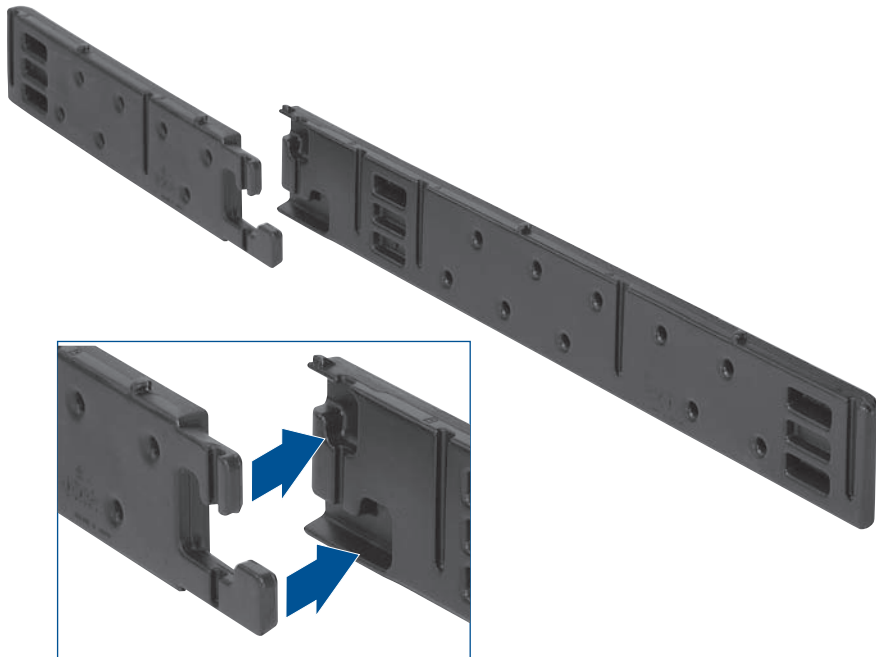

2 Pins

- Insert pins by sliding into side rails in the direction of the arrow (image A).
- Push firmly.
- Make sure that the top of the pin is flush with the top of the side rail (image B).

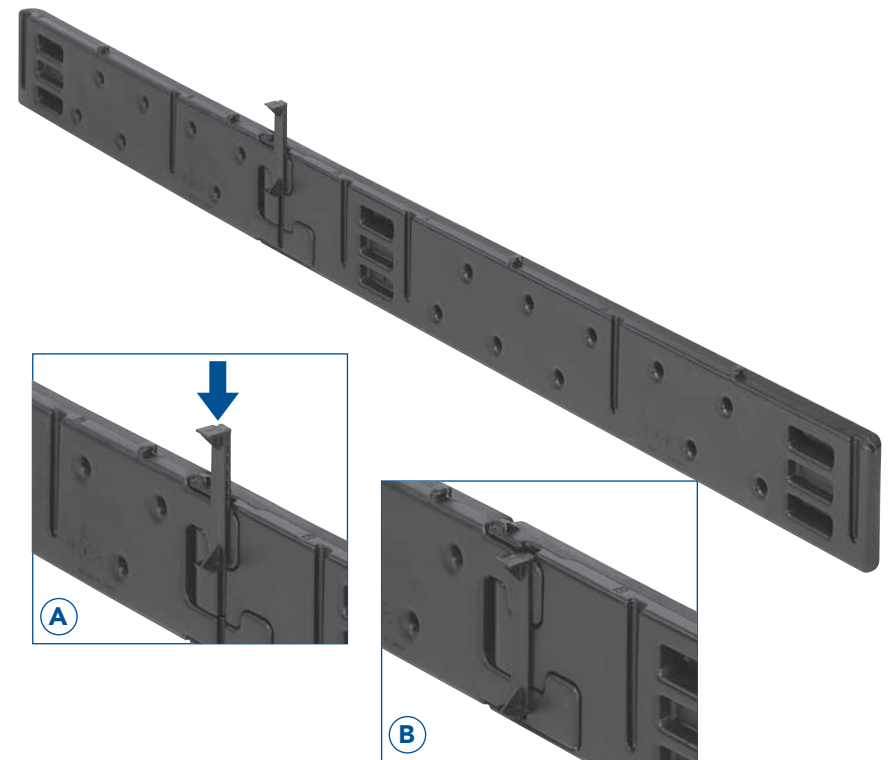

3 Legs (optional)

- Insert a bolt through side rail and leg holes. Hand-tighten wing nut and spring washer. Cupped side of the washer must face toward the leg and the bolt should be flush with side rail. Repeat for second hole and tighten firmly.
- Repeat for remaining legs.
- If you have a King/Cal King size bed, repeat the steps above for the second base.

- If you have a Queen base, attach 3 additional legs to support beams 1, 2 and 3 (see below).
- Check wing nuts 2-3 days after initial assembly to ensure proper tightness.

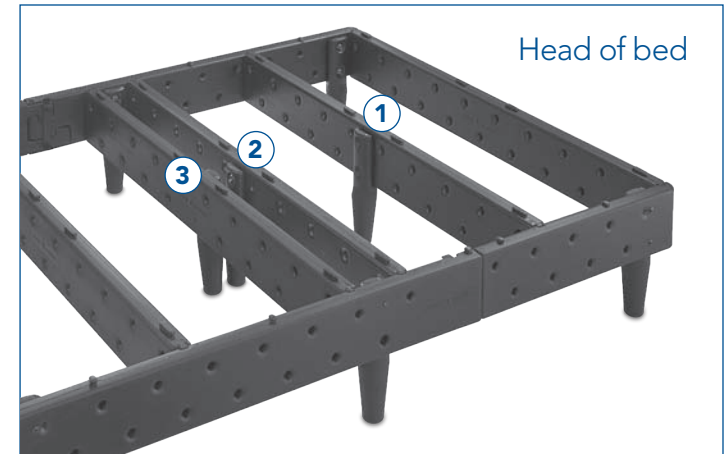
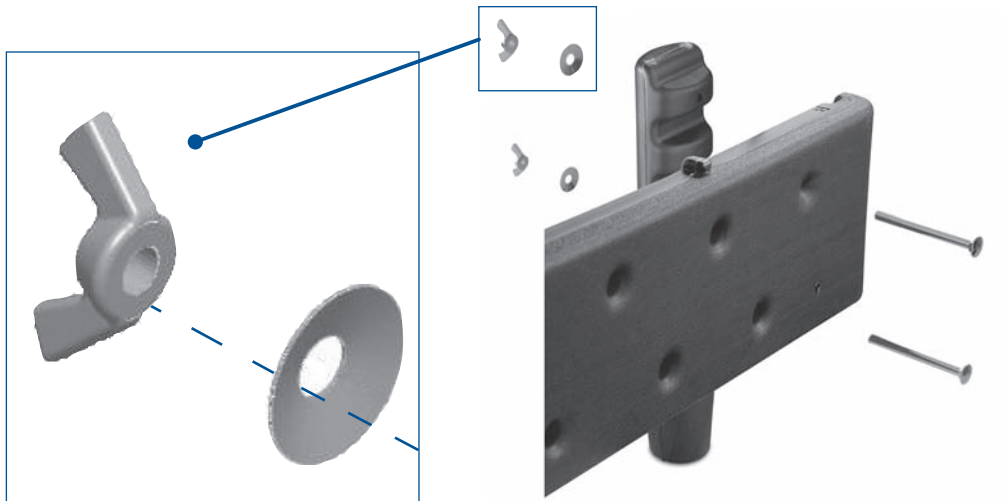

4 Support/End Beams

- Match “A” end of the support/end beam with the “A” groove of the side rail. Match “B” end of the support/end beam with the “B” groove of the side rail.

For Twin Extra-Long, Queen and King beds:

- Ensure the tabs are pointed up; slide one of the support beams into the end of the side rails at the head of the bed. Push firmly until top is flush; joints fit tightly.
- Slide remaining support beams into side rail grooves beginning at the head of the bed and progressing toward the foot. Be sure to match the “A” end of the support beam with the “A” groove of the side rail and the “B” end of the support beam with the “B” groove of the side rail.

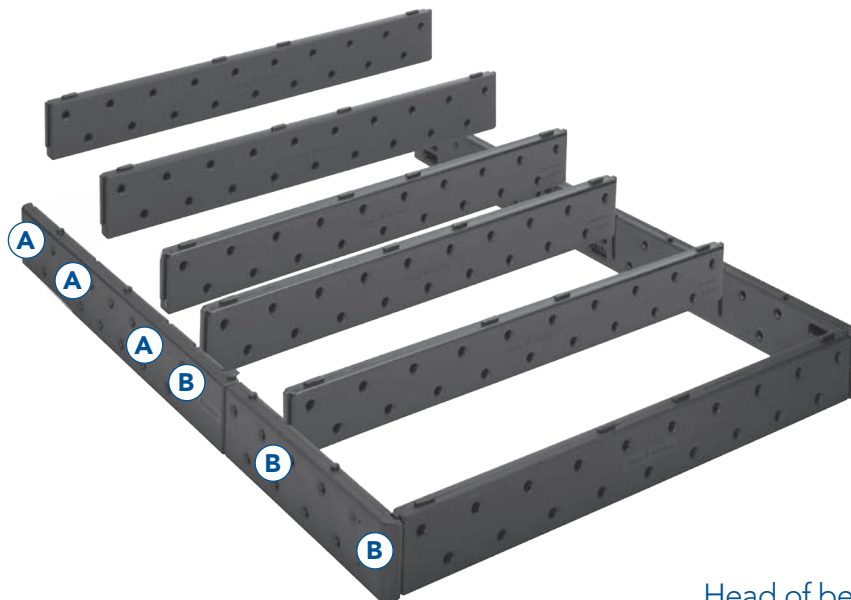

Head of bed

For Full, Double and California King beds:

- Ensure the tabs are pointed up; slide one of the beams labeled “end beam” into the side rails at the head of the bed, push firmly until top is flush; joints fit tightly.
- Slide support beams into side rail grooves beginning at the head of the bed and progressing toward the foot. Be sure to match the “A” end of the support beam with the “A” groove of the side rail and the “B” end of the support beam with the “B” groove of the side rail.
- Slide remaining beam labeled “end beam” into the grooves at the foot of the bed.



5 Firmness Control™ System

- Place the Firmness Control™ system under the base at the head of the bed. (If base is placed directly onto floor, place Firmness Control™ system next to the head of the base.)
- Plug the power cord into the Firmness Control™ system and into a surge protector. **IMPORTANT:** *Your Limited Warranty does not cover damage to the Firmness Control™ system due to a power surge, regardless of the source. See the Limited Warranty on page 28 for more details.*

NOTE: Do not plug surge protector into an outlet that is controlled by a wall switch.

- Extend hoses in front of the head of the bed and toward their respective sides of the bed (for dual chamber beds) or to one side (for single chamber beds).

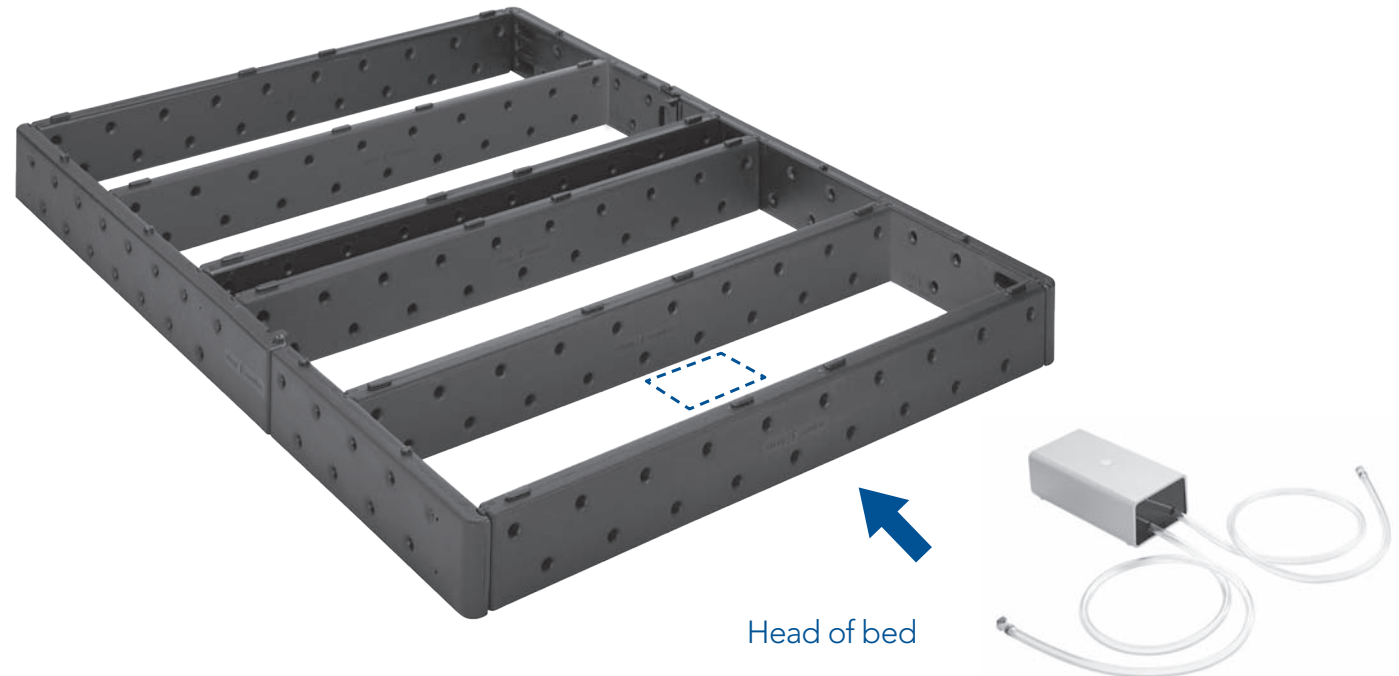

6 Deck Panels

- Slide deck panels onto frame from outside in, locking each deck panel into place by securing it to the tabs of the frame and beams.
- Ensure the deck panels are flush on all sides.
- Panels fit snugly; do not force.

NOTE: King and California King bases consist of two bases, side by side.

Full/Double/Queen

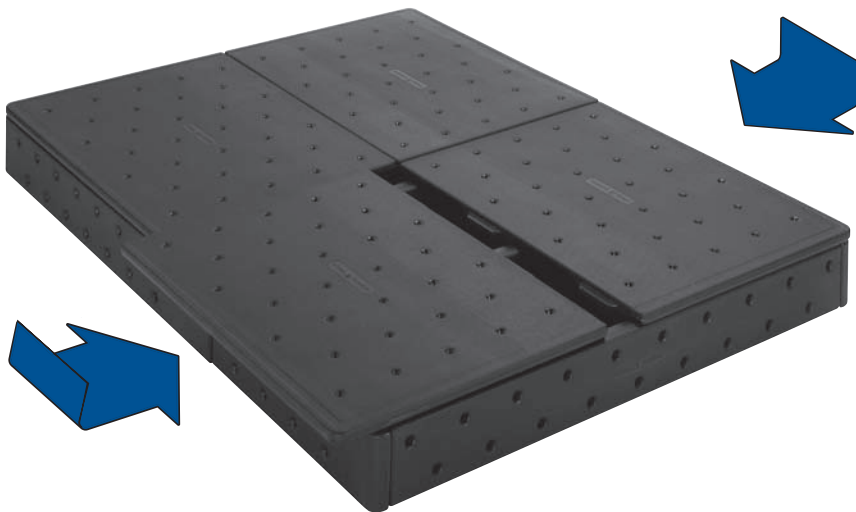

Twin Extra-Long

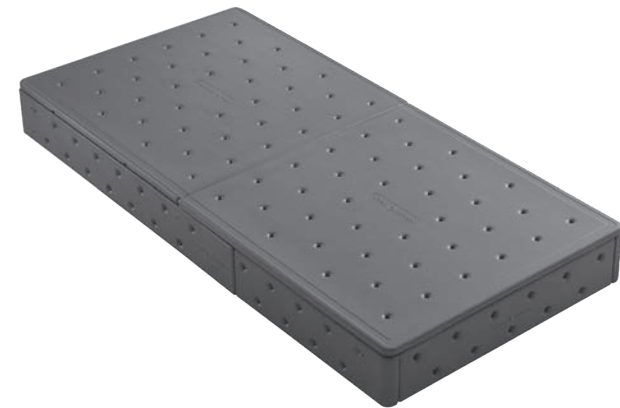

King/Cal King

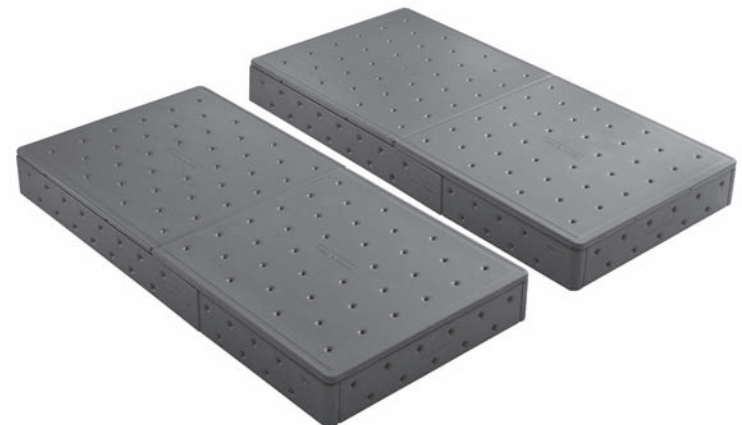

7 Coverlet

- Place coverlet on top of base.
- Carefully cover one corner at a time, positioning the seam at the head of the bed.

8 You're Done!

- Now turn the page to begin your mattress assembly.



Before You Begin

Assembling Your Mattress

Carefully check the contents of your mattress boxes.

Make sure you have the correct number of components for the size of bed you purchased. If you are missing any items listed to the right, please call 1.800.472.7185 or email Customer Service at customerservice@selectcomfort.com

Prepare your foam comfort layer(s).

Open and set aside. They'll need at least 30 minutes to fully expand.



Comfort. Individualized.SM

Our most advanced SLEEP NUMBER[®] DualAir[™] technology allows you to find your SLEEP NUMBER[®] setting, name your side of the bed, select your language and more – all at the simple touch of a button.

Mattress: What's Included

	Twin Extra-Long/Full	Double*/Queen	King/California King
Mattress Cover	1	1	1
Foam Border Walls	2 Short 2 Long	2 Short 2 Long	2 Short 2 Long
Center Foam Wall	0	1	1
Foam Comfort Layers	2	4	4
Foam Base Pad	1	1	1
Air Chambers	1	2	2
Firmness Control[™] System	1	1	1
Corner Locks	0	4*	0

Mattress Components

Mattress Cover



Foam Border Walls



Two short and two long

Center Foam Wall



Dual chamber beds only

Foam Comfort Layer(s)



Foam Base Pad

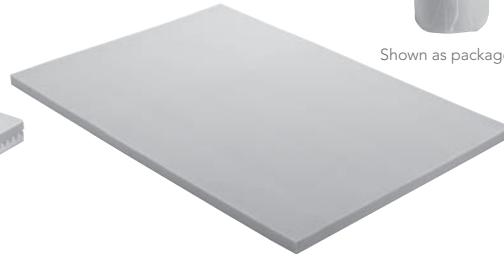

Shown as packaged

Corner Locks

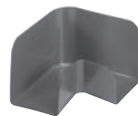

Double beds only

Air Chambers

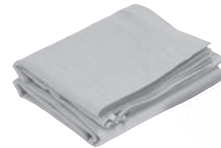

Firmness Control™ System



Remote

Some texture and surface appearances may vary from those shown.

Assembling Your Mattress

1 Mattress Cover

- Place mattress cover on mattress base or on existing bed platform, making sure openings in the bottom of the mattress cover are at the head of the bed.
- Unzip mattress cover at zipper A (see below).
- Set top of mattress cover aside.

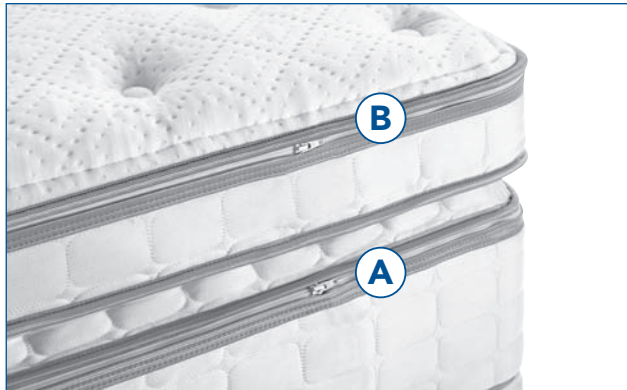

2 Foam Side Walls

- Place long border walls along inside of mattress cover, extending the entire length of the bed.
- Make sure that the notches are facing the center of the bed.

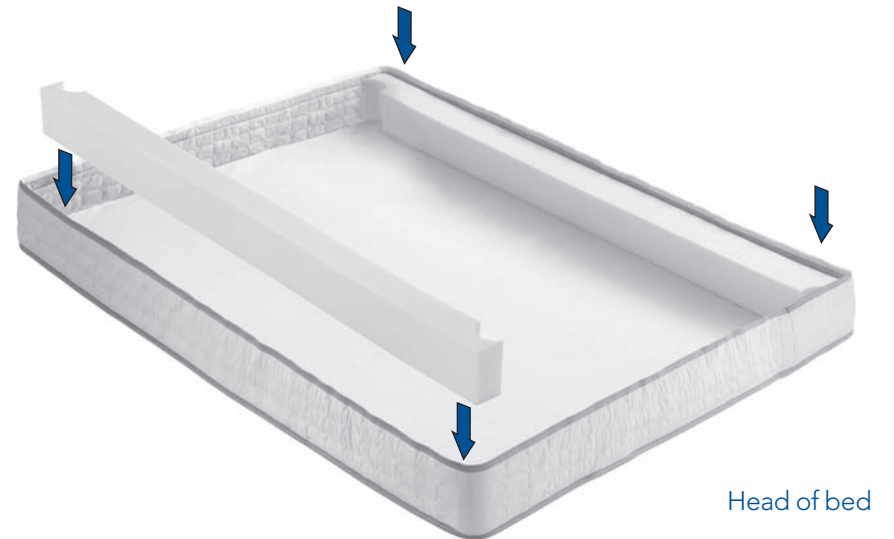

Double Beds Only - Corner Lock Assembly

- Place one corner lock in each corner of the mattress cover bottom.

IMPORTANT: Corner locks must be positioned under the border wrap.

- As you install the foam side and end walls, be sure the walls meet inside the corner locks at each corner. (Double beds use corner locks in place of notched side walls.)



3 Foam End Walls

- Place short border walls at the head and foot, between the side walls.
- Make sure the foam border walls are connected securely and squarely.
- Ensure that the zipper is aligned with the top edge of the foam border walls.

NOTE: It is okay if the foam walls bow to the inside of the bed at this point in the assembly.



Head of bed

4 Foam Base Pad

- Carefully shake out the pad.
- Place the foam base pad in the bottom of the mattress cover.



Head of bed

5 Air Chamber(s)

- Place air chamber(s) on top of foam base pad so the hose connectors face the head of the bed and lie on the bottom when inflated.

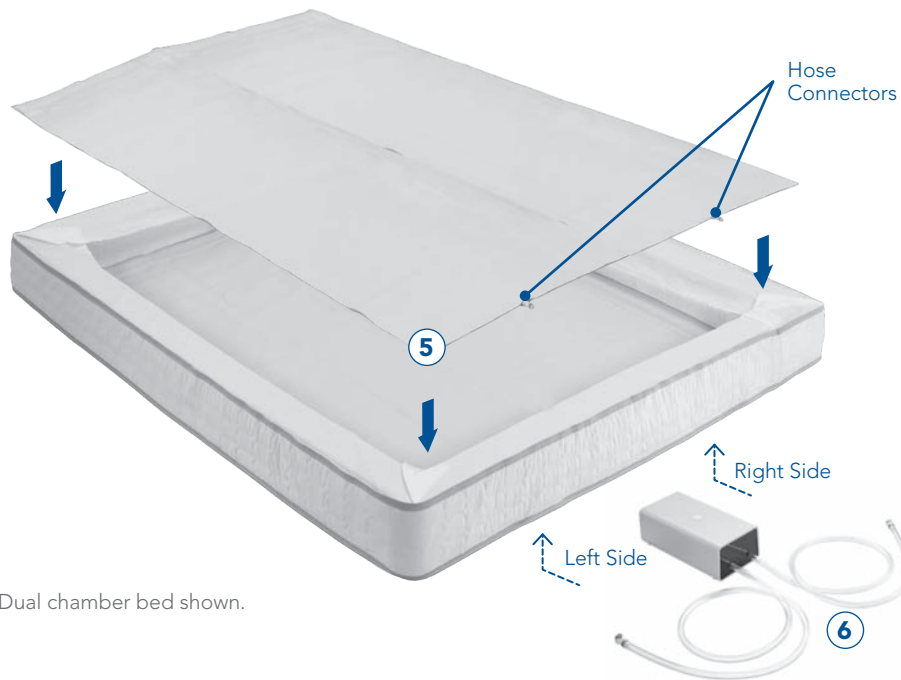

Dual chamber bed shown.

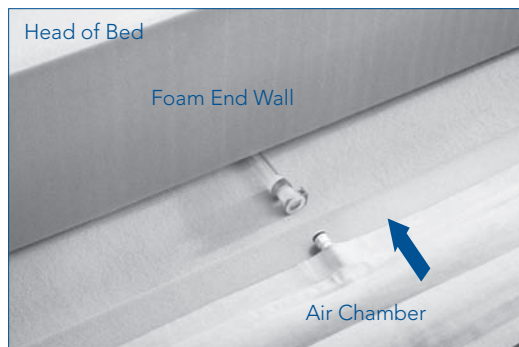

6 Firmness Control™ System

Firmness Control™ System for Dual Chamber Beds

- Pass the left Firmness Control™ system hose (marked with a white band) through the opening on the bottom left side of the mattress cover.
- Connect the Firmness Control™ system hose to the left air chamber by pushing together until you hear a click.
- Repeat for the right side of the mattress, using the Firmness Control™ system hose marked with a blue band.

Firmness Control™ System for Single Chamber Beds

- Pass the Firmness Control™ system hose through the opening on the bottom of the mattress cover.
- Connect the Firmness Control™ system hose to the air chamber by pushing together until you hear a click.

DualAir™ Technology Inside

At the heart of the SLEEP NUMBER® bed is our most advanced DualAir™ technology. Adjustable air chambers and a Firmness Control™ system easily find your ideal level of comfort and support on each side — your SLEEP NUMBER® setting.



7 Activate DualAir™ Technology

- Unplug and re-plug your Firmness Control™ system into a surge protector.
- Insert two AA batteries (included) into your remote.
- Your remote will turn on simply by picking it up or pressing any button. Easy-to-follow instructions will guide you through the next steps.
- First, select English or Spanish. Next, DualAir™ technology will engage automatically.
- Please wait while your mattress inflates. This will take a few minutes. When complete, you'll be prompted to complete your bed assembly.
- Proceed to step 8 in this manual.



8 Center Foam Wall (Dual Chamber Beds Only)

- Insert center foam wall between the air chambers.
- Zip air chambers together.



9 Border Wrap

- Extend the border wrap over the foam border walls as shown below.

Important Safety Notice: To ensure compliance with federal flammability requirements, the border wrap must be positioned correctly within the mattress as shown.



10 Duvet Cover

- Reattach mattress cover at zipper A.
- Remove mattress cover top at zipper B and set aside.



11 Foam Comfort Layers

- Place the foam comfort layer(s) on top of the duvet cover.
- Place either side up depending upon your preference.



Foam pattern varies by bed model.

Head of bed

12 Border Wrap

- Extend the border wrap over the foam comfort layers as shown below.

Important Safety Notice: To ensure compliance with federal flammability requirements, the border wrap must be positioned correctly within the mattress as shown.

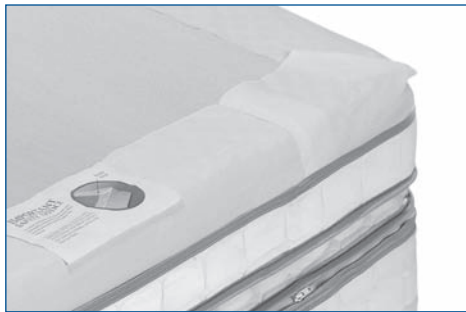

Head of bed

13 Mattress Cover Top

- To close mattress cover, place it on the bed with the zipper pull at the head of the bed.
- Make sure the zipper pin is completely inserted into the zipper box. Zip the top of the mattress cover closed.

Proper zipper alignment

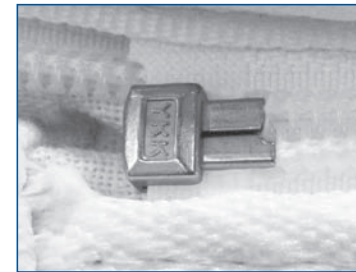

14 You're Done!

- Now turn the page to individualize your remote.

Individualizing Your Remote





For your most individualized sleep ever, the intuitive, easy-to-use remote allows you to find your ideal level of comfort, name each side of the bed, and more. Follow these steps to make it your own.

1 Name Each Side of the Bed

Follow the steps on your remote to enter your names on each side of the bed. If you'd like to skip this step, you can enter them later by pressing the Menu/Select button , **Settings** and **Rename Side**.





NOTE: You can choose your side of the bed at any time by pressing the Side button .

2 Save Your Sleep Number® Setting Into Memory

Press the Side button  to choose your side of the bed. If you already know your SLEEP NUMBER® setting, press the Up/Firmer  or Down/Softer button  to choose it, then press the My Sleep Number® Setting button  on top of your remote for two seconds to save your favorite setting.

3 Find Your Sleep Number® Setting

There's nothing quite like finding your *Sleep Number* setting. Your remote can easily guide you to your ideal level of comfort and support.

- Begin by lying on the bed in your preferred sleeping position.
- Press the Side button  to choose your side of the bed.
- Press the Menu/Select button .
- Use the Up/Firmer  or Down/Softer button  to scroll to **Settings**, then press the Menu/Select button .
- Choose **Find Sleep Number®**.
- Follow the instructions on your remote to find your favorite *Sleep Number* setting. This may take a few minutes.

4 More Sleep Number® Remote Features

Press the Menu/Select button  to bring up the menu. From here you can change your SLEEP NUMBER® setting, rename your side of the bed, find customer support information and more.

My Sleep Number®

Return to your favorite *Sleep Number* setting at any time.

Sleep Number® 100

Automatically adjusts one or both sides of the mattress to the firmest *Sleep Number* setting.

Settings

- **Find Sleep Number®** guides you to your ideal level of firmness, comfort and support.
- **Set Sleep Number®** to quickly select and save a new favorite *Sleep Number* setting.
- **Rename Side** to name either side of the bed.
- **Customer Support** gives you contact information if you have any questions.
- **Back** returns you to the main menu.

Exit

Displays your most recent *Sleep Number* setting.



Getting Comfortable with Your Sleep Number® Setting

Once you've found a comfortable SLEEP NUMBER® setting, it's a good idea to evaluate your support and alignment. As you lie in your preferred sleeping position, check whether or not your neck and back feel aligned. Make sure there's no pressure or discomfort in your shoulders and hips. The mattress should support the small of your back (for back sleepers) or the curve of your side (for side sleepers). It's also important to have a pillow that fits you properly otherwise it may interfere with your ability to sleep comfortably. At a SLEEP NUMBER® store, one of our Sleep Professionals can expertly determine which pillow keeps your head, neck and shoulders in alignment with our exclusive PillowFit® process.

Give It Time

Sometimes it takes a little while to discover your ideal *Sleep Number* setting. When you have found a *Sleep Number* setting where you feel comfortable, try it for three to five nights. After five nights, reevaluate your comfort level and only adjust the setting in increments of 5–10. Repeat the process until you have found the perfect setting for you.

If, after trying four different *Sleep Number* settings, you have not found your ideal *Sleep Number* setting and would like additional assistance, visit sleepnumber.com and click on Customer Service or call 1.800.472.7185 to reach a Customer Service Representative. Our trained Customer Service Representatives will provide help to improve your comfort.

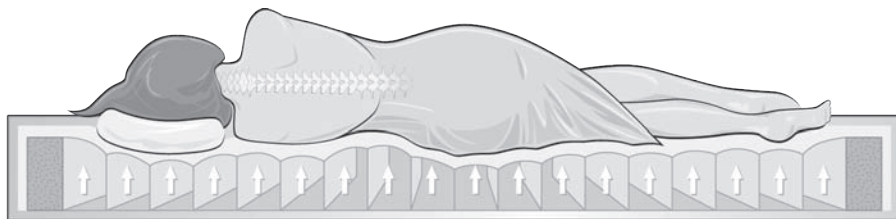

Right

- Neck and back are aligned in the same position as when you are standing
- No discomfort at shoulder and hip pressure points
- You feel the mattress support the small of your back (back sleepers) or the curve of your side (side sleepers)

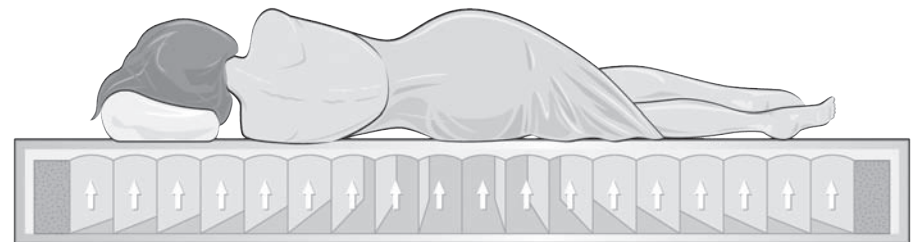

Wrong

- Body alignment is not straight
- Your pillow makes your head tilt at an angle from the rest of your body
- You feel discomfort from pressure at your neck, shoulders, back, hips or legs

Things to Remember

Reasons you may wish to adjust the firmness of your bed:

- strained muscles
- back pain
- weight change
- pregnancy
- sunburn
- new sleeping position

Tips for a Great Night's Sleep

Not getting 8 hours of sleep a night? Don't despair.

These tips from the experts at SLEEP NUMBER can help you fall asleep more easily and sleep more soundly.

- Keep a regular sleep schedule, even on the weekends.
- Avoid TVs, computers, phones and tablets before bedtime.
- Exercise regularly, but not too close to bedtime.
- Eliminate caffeine after noon.

Sleep Number® Setting Study

As you can see in the chart below, SLEEP NUMBER® bed owners find comfort at all settings from 5-100, however the majority of sleepers find their *Sleep Number* setting between 35 and 50.

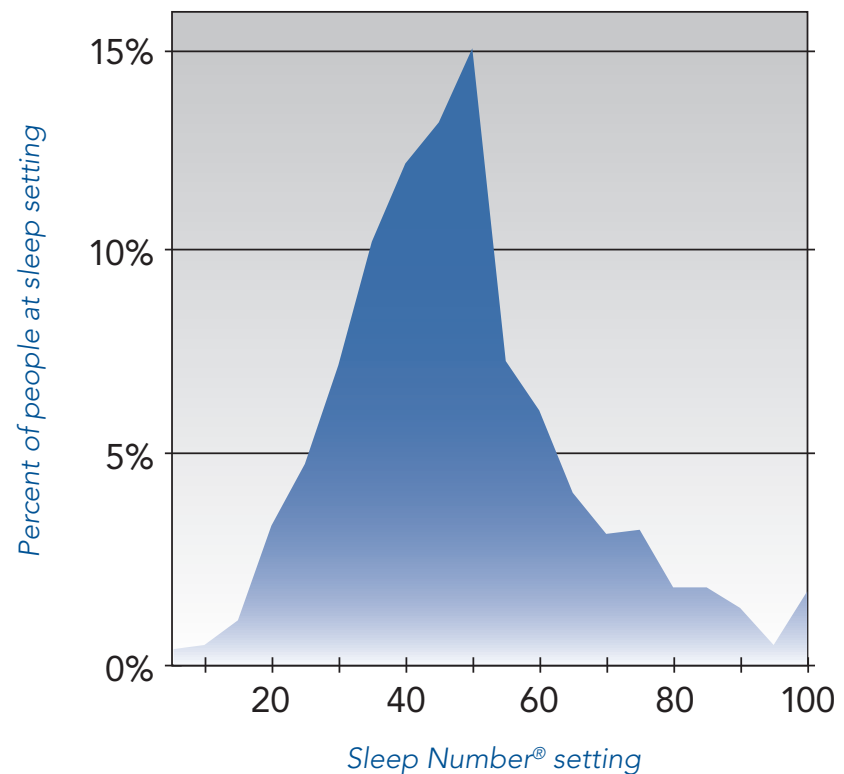

Product Care

Cleaning Your Mattress

Spot clean the cover of your SLEEP NUMBER® mattress with carbonated water. Do not dry clean the mattress cover or put it in a washing machine. Do not apply stain guard; it may cause the fabric to turn yellow.

SLEEP NUMBER is an industry leader in the use of materials designed to inhibit the growth of allergens or microorganisms.

Advanced antimicrobial safeguards are incorporated into every SLEEP NUMBER® bed. Key components of the mattress have been treated to protect the bed from contaminants such as mold, mildew and bacteria growth. The unique, zip-open design of the *Sleep Number* bed allows you to easily open, ventilate or vacuum if you choose.

In rare instances and under the right conditions, mold or mildew can form inside many types of mattresses, bedding or upholstered products. Should this condition occur in your mattress, please contact our Customer Service department at 1.800.472.7185 so we can work with you to return your bed to factory-fresh condition.



Cleaning Your Remote

- Wipe the body with a clean cloth dampened with a mild soap and water solution.
- Wipe the display screen with a clean, dry, lint-free cloth.

CAUTION: Do not immerse in water or place in dishwasher.

Moving Your Sleep Number® Bed

- Always disassemble the base. Bag all hardware so that it is not lost.
- The mattress can be fully inflated, capped off and packaged in a mattress box for moving.
- If you don't have a mattress box, double-bag the cover and foam to prevent stains. Deflate and box the air chamber(s) to prevent possible damage.
- Pack the Firmness Control™ system in a box with packing material. Transport with minimal exposure to shock and vibration.
- Remove batteries from remote.
- Tuck the remote, air chamber caps and instructions in the box with the Firmness Control™ system to prevent them from being lost.

Sleep Number® Bedding Collection

Sleep your best with our exclusive bedding solutions. From temperature balancing to natural allergy defense, discover bedding innovations designed to meet your unique comfort needs. For a truly individualized sleep experience.

- PillowFit®
- Temperature Balancing
- Natural Allergy Defense
- All Natural
- Warming

Experience PillowFit®

Our Sleep Professionals will use PillowFit® expertise to find the firmness, fill and fit for you. Only at a SLEEP NUMBER® store.

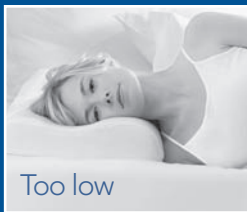



Warranty

100 Night In-Home Trial and Return Policy

We are confident that you will be completely satisfied with your SLEEP NUMBER® bed. Please take into consideration that it may take several weeks to adjust and get completely comfortable. After 30 nights, if for any reason you decide to return the bed, contact Customer Service before packing your bed. Simply call us toll-free within 100 days of delivery to authorize its return. Upon receipt, we'll reimburse the full purchase price less your initial shipping or Home Delivery and Setup fees. You pay return shipping. There are no returns or exchanges on adjustable bases, closeout, Special/Limited Edition or demo bed models. All merchandise being returned must be in good condition and be given a Return Merchandise Authorization number from Customer Service, which will expire 30 days from date of issue. All refunds will be issued to the original method of payment within approximately 15 business days after all products have been received at SLEEP NUMBER. All shipping and incidental charges to return the bed are the customer's responsibility.

Defective or Damaged Components

If any component of the mattress or Firmness Control™ system is found to be defective in materials or workmanship within the first two years of the original purchase date, they will be replaced by *Sleep Number* at no cost to you. Within the first two years, all shipping charges to replace a defective component will be covered by *Sleep Number*. If any component of the mattress or Firmness Control™ system is found to be defective in materials or workmanship after two years from the original purchase date, the terms of the Limited Warranty will apply. After two years from the date of purchase, you will be responsible for the cost of shipping the defective component back to *Sleep Number* and any related costs. Contact our Customer Service department at 1.800.472.7185 for troubleshooting assistance and if you need to process a replacement order.

In the event that replacement components are required or if you wish to upgrade to newer components that are not covered in the warranty, you may purchase these items by simply providing proof of purchase. All component sales are final and carry a 2-Year Limited Warranty from the purchase date. Product discounts and bedding promotions do not apply to components. For current pricing and to process a component purchase, call our Customer Service department at 1.800.472.7185.

Sleep Number® Mattress and Modular Base Limited Warranty

Select Comfort Corporation ("Sleep Number") warrants this mattress and/or mattress base against defects in material or workmanship to the original purchaser for a period of twenty-five (25) years from the date of original purchase or invoice, whichever is later.

WHAT WE WILL DO: At our option, *Sleep Number* will repair or replace the warranted product or part provided that it is returned to us as provided herein. During the first two (2) warranty years, any covered repairs or replacement parts will be at no cost to you. *Sleep Number* reserves the right to substitute products or parts of comparable quality and value or, where permissible by law, to use or deliver refurbished products or parts in

the repair or replacement of any product or part that does not come into contact with the sleep surface (e.g. the Firmness Control™ system or the air chambers) under this limited warranty.

HOW WARRANTY COVERAGE IS CALCULATED: During the following warranty years, your repair or replacement cost will be calculated by adjusting our then-current prices for the product or part (or a comparable product or part if the original product or part is no longer in production) as follows:

Warranty Year	Original Purchaser's Percent of Product/Part Cost
0-2	No Cost
3-20	20% plus 4% for each <u>completed</u> year from original purchase or invoice date, whichever is later
21-25	96%

WHO THIS WARRANTY PROVIDES COVERAGE TO: Your warranty is non-transferrable and sale, transfer or disposal of the warranted product or part will void this warranty. For the purposes of this warranty, an "original purchaser" is an individual who purchases the product directly from *Sleep Number* or an authorized reseller for personal, consumer use and not with the intent to resell the product or use for commercial purposes. This warranty does not apply to products purchased either with the intent to resell or through unauthorized resellers including, without limitation, third party websites such as Craigslist, eBay, or Amazon. If you are not the original purchaser, you take the product "as is" and with any and all faults.

CLAIMS THIS WARRANTY DOES NOT COVER: Your warranty excludes claims for conditions arising from normal wear and tear including but not limited to mattress cover compression, foam compression, discoloration of parts or normal body indentations. This warranty does not provide coverage for claims related to comfort preference (e.g. "The bed feels too hard/soft."). The warranty does not provide coverage and will become void if claims are a result of damage caused by tampering with or modifications to any component including the opening of the Firmness Control™ system or remote control. Damage caused from laundering or dry-cleaning the product or any part as well as damage caused by misuse or abuse including but not limited to stains, soil, burns, cuts, tears or spills or factors other than a product defect are also excluded under and will void this warranty. Lastly, this warranty does not provide coverage and will become void if damage is caused by acts of nature or relating to forces outside Select Comfort's control including but not limited to fire, flood or lightning damage or for damage caused by power surges. This warranty does not apply to beds sold as floor models or "demos." Changes in barometric pressure can impact the feel of your SLEEP NUMBER® mattress and may require you to occasionally adjust your Firmness Control™ system to return to your preferred SLEEP NUMBER® setting. This is normal, is a function of the environment, and does not reflect any defect in your *Sleep Number* mattress or Firmness Control™ system. Consequently, this warranty will not cover claims caused by changes in barometric pressure.

COSTS THIS WARRANTY DOES NOT COVER: In connection with your warranty claim, you are responsible for returning the warranted product or part to us. If your claim occurs during the first two warranty years, we will incur both the cost of shipping the warranted product or part back to us as well as the cost of our shipment of any repaired or replaced

product or part back to you. If your claim occurs after the first two warranty years, shipping of products or parts related to your warranty claim will be at your expense in both directions. In either case, you remain responsible for bringing your authorized return to your nearest UPS facility or drop-off location. This warranty does not provide coverage for or the cost associated with the transportation, inspection, removal or installation of any product or parts except as provided above. The responsibility for the installation of any product or part replaced under this warranty and any related installation costs are yours regardless of whether there is any cost to you for the repaired or replaced product or part.

WHAT YOU MUST DO TO KEEP THE WARRANTY IN EFFECT:

KEEP YOUR ORIGINAL RECEIPT. You may be required to provide your original receipt at the time of any warranty claim.

USE AN APPROPRIATE FOUNDATION. Your SLEEP NUMBER® mattress is designed to work on a firm, solid, non-spring foundation or adjustable bed base that is sufficiently strong and stable so as being capable of supporting the weight of the mattress and its occupants. Failure to use an appropriate foundation will void your warranty.

DO NOT REMOVE THE LAW LABEL. Do not remove the law label attached to your *Sleep Number* mattress. This label identifies your mattress as being a genuine *Sleep Number* mattress and may be required to establish warranty coverage.

KEEP THE MATTRESS AND/OR BASE IN A SANITARY CONDITION. This warranty shall not apply to any product or part found to be in an unreasonably unsanitary condition. A product is in an unreasonably unsanitary condition if it is so pervasively soiled that an inspection is unable to be conducted due to the presence of body fluids, blood borne pathogens, insects or other substances that otherwise suggest that the product has been subjected to misuse or abuse beyond ordinary wear and tear.

WHAT IS THE WARRANTY ON REPAIRED OR REPLACED PRODUCTS OR PARTS? No new warranty is provided with any mattress or any component part that is repaired or replaced under this warranty. The warranty for any replacement mattress or component part runs from the date of your original purchase or invoice date, whichever is later. Any mattress or component part that is replaced under this warranty will be required to be returned to SLEEP NUMBER at the time of replacement.

WHERE DOES THIS WARRANTY APPLY? Your warranty provides coverage for products purchased and used in the United States excluding its territories and possessions (e.g. Guam, Puerto Rico and the Virgin Islands). It is not applicable to claims for products purchased or used in any other country.

WHAT ARE THE LIMITATIONS ON THIS WARRANTY? Your exclusive remedy, in lieu of all incidental, special or consequential damages, including for negligence, is limited to repair or replacement of any product or component deemed to be defective under the terms and conditions stated in this warranty. SLEEP NUMBER SHALL NOT BE LIABLE IN ANY CASE FOR INCIDENTAL OR CONSEQUENTIAL DAMAGES RESULTING FROM THE USE OF THIS PRODUCT OR ARISING OUT OF ANY BREACH OF THIS WARRANTY EVEN IF IT HAS BEEN ADVISED OF THE POSSIBILITY OF SUCH DAMAGES.

ARE THERE ANY IMPLIED WARRANTIES? EXCEPT TO THE EXTENT PROHIBITED BY APPLICABLE LAW, ANY IMPLIED WARRANTY OF MERCHANTABILITY OR FITNESS FOR A PARTICULAR PURPOSE APPLICABLE TO YOUR SLEEP NUMBER® MATTRESS AND/

OR BASE IS LIMITED IN DURATION TO TWO YEARS. EXCEPT AS OTHERWISE MAY BE REQUIRED BY LAW, THERE ARE NO OTHER EXPRESSED OR IMPLIED WARRANTIES OTHER THAN THE WARRANTY DESCRIBED HEREIN. *Sleep Number* does not make any warranty and specifically disclaims any warranty that your *Sleep Number* mattress and/or base is suitable for your particular medical condition. No express or implied warranties are extended to any persons who purchased the product from anyone other than *Sleep Number* or its authorized retailers and all such warranties are hereby excluded. *Sleep Number* does not authorize any person or entity to create for it any other obligation or liability in connection with this warranty.

HOW STATE LAW RELATES TO THIS WARRANTY: Some states do not allow the exclusion or limitation of incidental or consequential damages or limitations on how long an implied warranty lasts so the foregoing limitations may not apply to you. This warranty gives you specific legal rights. You may also have other rights. These rights may vary from state to state.

HOW TO FILE A WARRANTY CLAIM: You must contact our Customer Service department at the phone number printed on the back cover of your owner's manual to obtain a Return Merchandise Authorization (RMA) number prior to returning any products or parts to us. You may be asked to undertake certain steps to troubleshoot the product or part for which a claim is being made. These steps are essential to determining whether your warranty claim is covered and ensuring shipment of the correct replacement product or part. Products or parts returned to us without an RMA will be destroyed and no warranty claim will be honored. You may also contact us by email at customerservice@selectcomfort.com or in writing to: Sleep Number Customer Service, 9800 59th Avenue North, Minneapolis, MN 55442.

Firmness Control™ System Notification

This device complies with Part 15 of the FCC Rules. Operation is subject to the following two conditions: (1) this device may not cause harmful interference, and (2) this device must accept any interference received, including interference that may cause undesired operation. To comply with the FCC RF exposure compliance, no change to the antenna or device is permitted. Any change to the antenna or device could result in the device exceeding the RF exposure requirement and void user's authority to operate the device.

Important Safety Instructions:

- Your SLEEP NUMBER® bed is intended for in-home, non-commercial use only. Any unintended use voids the limited warranty.
- The remote is not a toy and should be used under adult supervision.
- Do not open the Firmness Control™ system or remote(s) (with the exception of the battery compartment). The warranty is void if these units are tampered with.
- Keep the Firmness Control™ system and remote(s) away from heat sources such as radiators, heat registers, etc.
- Firmness Control system and remote(s) are not water resistant. Do not use or store near water – for example, in a wet basement, near an open window, etc.

Frequently Asked Questions

Base FAQ's

- Q. What if I can't get my center support beams flush with the side rails?
- A. Make sure the letter on the support beam matches the letter on the side rail. For example, the end of the support beam labeled "A" should connect to the side rail labeled "A." Additional force may be required.
- Q. How can I get my pins in all the way?
- A. Slide pins into side rails in the direction of the arrow. Make sure that the top of the pin is flush with the top of the side rail.
- Q. What can I do if I can't get the deck panels to lie flat?
- A. First, make sure all the pins and beams are flush. Then, set the deck panel over the notches. You should then be able to slide the panel inward into place.
- Q. Where is the hardware for the footboard and headboard brackets?
- A. The same hardware for attaching the legs to the base is used for attaching the brackets (sold separately).



Mattress FAQ's

Q. Where are the air chamber caps? And where should I store them?

- A. The caps are in the Firmness Control™ system box. Please store these in the mattress cover at the head of the bed in case you should ever need to temporarily cap your air chamber(s).



Q. What if my foam comfort layer appears to be too small or irregular?

- A. Gently shake the layer as you place it on your mattress and it will recover its full size overnight.

Q. What if I feel like I'm rolling toward the edge or toward the center of the mattress?

- A. Although rare, these sensations could potentially be experienced if one side of the mattress is set quite firm and the other side quite soft. Call Customer Service at 1.800.472.7185 for a remedy to this situation if bothersome to you.

Q. What if I notice a rubber smell from the air chamber(s)?

- A. The odor you may smell is non-toxic and will fade over time. To minimize the smell, unzip the mattress cover and allow the air chamber to air out for a few hours. Laying a couple of dryer sheets on top of the air chamber will also help mask any odor by adding a fresh scent.

Q. Why are there body impressions on the mattress cover?

- A. For a fuller look, use your Sleep Number® 100 function. If there are still body impressions in the cover, remove and shake the quilted top to restore some of the loft. In addition, a household vacuum nozzle may be used to fluff the cover.

Body impressions in a normal innerspring mattress would indicate that the spring support is compressing or breaking down. The SLEEP NUMBER® bed features air, which we believe is superior in every way for comfort and support. Since air cannot break down, you receive the same support after years of use as you do on the very first day.



Firmness Control™ System FAQ's

Q. Why does my Sleep Number® setting change?

- A. Your SLEEP NUMBER® setting is based on the combination of body weight, volume of air in the air chamber and sleep position. Several factors may contribute to fluctuations in your *Sleep Number* setting:
- Temperature can cause changes in your *Sleep Number* setting. For example, a heated mattress pad will cause the *Sleep Number* setting to increase.
 - Barometric pressure related to weather and altitude can cause your *Sleep Number* setting to change.
 - Weight can affect your *Sleep Number* setting. The Firmness Control™ system acts similarly to a scale. More weight means a higher *Sleep Number* setting.
 - Different sleep positions can affect your *Sleep Number* setting. The more concentrated the weight is, the greater chance the *Sleep Number* setting will be higher (e.g., when you lie on your side). When weight is distributed more evenly throughout the chamber, it is more likely that the *Sleep Number* setting will be lower (e.g., when you lie on your back or stomach).

Q. What do I do if the Firmness Control™ system doesn't run?

- A. Make sure the power cord is securely plugged into the Firmness Control™ system and a surge protector. Verify that the power cord is plugged into an outlet that has power and is not connected to a wall switch.

Q. I feel the mattress is losing air. What should I do?

- A. Air loss can be caused by an unsecured hose connection, a defective air chamber, or a defective Firmness Control™ system. First, make sure the hoses are securely connected to the air chambers. If you do not find any damaged or loose connections, identify which of the following situations matches your situation and follow the instructions for remedying your issue.

NOTE: To avoid variations in your *Sleep Number* setting or level of comfort, make sure that you are lying in your preferred sleep position when adjusting and checking your *Sleep Number* setting.

If you have a dual air chamber bed and suspect only one (1) side of your SLEEP NUMBER® bed is getting softer:

- Inspect the o-ring and connectors for cracking or damage.
- Switch the hoses on the air chambers so the left hose (marked with a white band) is attached to the right air chamber and the right hose (marked with a blue band) is attached to the left air chamber. You should hear a click when the hose is securely connected to the air chamber.
- Fill the air chambers to the appropriate *Sleep Number* setting(s) for the person sleeping on each side of the bed.
- Sleep on the bed and monitor the feel of the bed's firmness on both sides.
- If neither chamber feels softer over time, you may have had a loose connection that was fixed when the hoses were switched. Switch the hoses back to their correct positions and continue to use the bed as usual.
- If an air chamber feels softer after switching hoses, contact Customer Service with the results (the issue stayed on the same side of the bed or it moved to the other side after switching hoses).

If you have a dual air chamber bed and both (2) air chambers are getting softer or you have a single air chamber bed and feel the air chamber getting softer:

- Inspect the o-ring(s) and connector(s) for cracking or damage, then reconnect the Firmness Control™ system to the air chamber(s).
- Lie down in your normal sleep position and fill the air chamber(s) with suspected air loss to your normal *Sleep Number* setting plus

an additional 15 points (e.g., if you sleep at 35, fill to 50). Over-inflation will compensate for air that may escape in one of the next steps.

- Locate the air chamber caps that came with your bed.*
- Disconnect the hose(s) from the air chamber(s) and quickly cap the chamber(s).
- Leave the air chamber(s) capped for a minimum of 48 hours.
- If the air chamber(s) become noticeably softer when capped, contact Customer Service.
- If the air chamber(s) hold air, reconnect the hose(s) and continue using the bed. The air loss issue may have been due to environmental factors or a connection issue. Contact Customer Service if the air loss issue returns after reattaching the Firmness Control™ system.

*Air chamber caps are typically found at the head of the bed inside the mattress cover in a small plastic bag. If you cannot find the caps, they may be available at your nearest SLEEP NUMBER® store or you can request them by emailing SLEEP NUMBER at CustomerService@selectcomfort.com with your request, or by calling 1.800.472.7185.

Q. Will my bed deflate if there is a power surge or power loss?

A. No, your mattress will maintain its firmness. To protect your Firmness Control™ system, we recommend using a surge protector.

NOTE: The warranty does not cover damage to the Firmness Control™ system due to a power surge. Using a surge protection device (not included) is recommended.

Q. How will I know if there's a problem, like the chamber isn't inflating or the system isn't receiving power?

A. The remote is designed to let you know if something isn't working

like it's supposed to. An error message will let you know an issue has been detected, along with prompts for how to fix it. If the error is still not resolved, you will be instructed to visit sleepnumber.com/chat or to call us at 1.800.472.7185.

Remote Control FAQ's

Q. How do I change my remote language to Spanish/English?

A. To change the language, hold the Menu/Select button for five seconds and follow directions on the remote.

Q. How do I capitalize a letter in the middle of my name?

A. Select the letter and press the up/down arrows simultaneously.



Q. How many characters can I use for my name?

A. Eleven.

Q. My remote says there's an inflation/connectivity error. What should I do?

A. An error message lets you know an issue has been detected, along with prompts for how to fix it. If the error is still not resolved, you will be instructed to visit sleepnumber.com/chat or to call us at 1.800.472.7185.

Q. How do I restore the remote's original settings?

A. To erase all stored information, hold down all three buttons (Up/Down/Menu)    simultaneously for seven seconds.

Q. Why won't my remote turn on?

A. You may need to replace the batteries. Your remote comes with two AA batteries that should last about six months with normal use. If new batteries don't resolve the issue, please visit sleepnumber.com/chat or call us at 1.800.472.7185.

Welcome to Sleep Number® InnerCircleSM

Congratulations on the purchase of your SLEEP NUMBER® bed. As a *Sleep Number* bed owner you are now an Insider, a member of our InnerCircle.SM Soon you'll be enjoying all the benefits of a better night's sleep on your new *Sleep Number* bed.

Register Today for Insiders-Only Benefits

Go to sleepnumber.com/innercircle

Simply register your bed to start receiving exclusive discounts. Plus, you'll get access to pass-along coupons to share with friends and family, and everyone you know who could use a better night's sleep.

Receive special savings.

You'll always get 10% off every purchase. And, throughout the year, we'll send you additional Insider-exclusive offers on beds and bedding.

Earn rewards.

Improve the lives of friends and family by sharing what you love about your *Sleep Number* bed. Enjoy an exclusive Insiders reward of \$100 for referrals ONE through NINE who purchase a bed. When your 10th referral purchases, you will receive another \$699 for a total of \$1,599 in rewards.

Be the first to know.

As an Insider, you'll be the first to know about our latest innovations, from new *Sleep Number* beds to bedding solutions that will improve your sleep.





Help is just a click or phone call away.

If you ever have questions or need help finding your ideal comfort, please visit us at sleepnumber.com/chat to chat with a live representative 7 a.m. – 11 p.m. (Central Standard Time) daily or call [1.800.472.7185](tel:18004727185)

Representatives are available by phone
(Central Standard Time):

Monday-Friday	8 a.m. – 8 p.m.
Saturday	8:30 a.m. – 5 p.m.
Sunday	Closed



9800 59th Avenue North, Minneapolis, MN 55442



119141

©2013 Select Comfort 8/13